

JVC

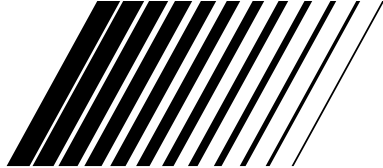

VIDEO CASSETTE RECORDER

HR-J785EK

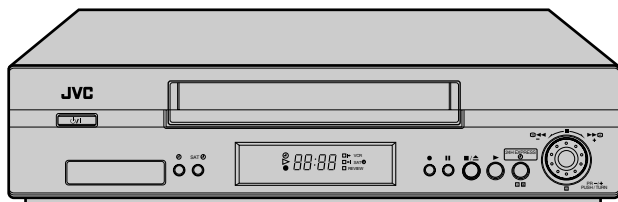

SQP B

VIDEO *Plus+* *Hi-Fi* **VHS**
DELUXE PAL

INSTRUCTIONS



Safety Precautions

The rating plate and the safety caution are on the rear of the unit.

WARNING: DANGEROUS VOLTAGE INSIDE

WARNING: TO PREVENT FIRE OR SHOCK HAZARD, DO NOT EXPOSE THIS UNIT TO RAIN OR MOISTURE.

IMPORTANT

- Please read the various precautions on pages 2–4 of this instruction manual before installing or operating the recorder.
- It should be noted that it may be unlawful to re-record pre-recorded tapes, records, or discs without the consent of the owner of copyright in the sound or video recording, broadcast or cable programme and in any literary, dramatic, musical, or artistic work embodied therein.

IMPORTANT

Connection to the mains supply in the United Kingdom. DO NOT cut off the mains plug from this equipment. If the plug fitted is not suitable for the power points in your home or the cable is too short to reach a power point, then obtain a proper safety approved extension lead/adaptor or consult your dealer.

In the unlikely event of the plug fuse failing be sure to replace the fuse only with an identical approved type, as originally fitted, and to replace the fuse cover. If the fuse fails again consult your nearest JVC dealer.

If nonetheless the mains plug is cut off remove the fuse and dispose of the plug immediately, to avoid a possible shock hazard by inadvertent connection to the mains supply.

If this product is not supplied fitted with a mains plug then follow the instructions given below:

DO NOT make any connection to the Larger Terminal coded E or Green.

The wires in the mains lead are coloured in accordance with the following code:



If these colours do not correspond with the terminal identifications of your plug, connect as follows:

Blue wire to terminal coded N (Neutral) or coloured Black.

Brown wire to terminal coded L (Live) or coloured Red.

If in doubt — consult a competent electrician.

CAUTION

- When you are not using the recorder for a long period of time, it is recommended that you disconnect the power cord from the mains outlet.
- Dangerous voltage inside. Refer internal servicing to qualified service personnel. To prevent electric shock or fire hazard, remove the power cord from the mains outlet prior to connecting or disconnecting any signal lead or aerial.

The **STANDBY/ON** ⏻/⏻ button does not completely shut off mains power from the unit, but switches operating current on and off. “⏻” shows electrical power standby and “⏻” shows **ON**.

Video tapes recorded with this video recorder in the LP (Long Play) mode cannot be played back on a single-speed video recorder.

When the equipment is installed in a cabinet or a shelf, make sure that it has sufficient space on all sides to allow for ventilation (10 cm or more on both sides, on top and at the rear.)

When discarding batteries, environmental problems must be considered and the local rules or laws governing the disposal of these batteries must be followed strictly.

Failure to heed the following precautions may result in damage to the recorder, remote control or video cassette.

1. DO NOT place the recorder...

- ... in an environment prone to extreme temperatures or humidity.
- ... in direct sunlight.
- ... in a dusty environment.
- ... in an environment where strong magnetic fields are generated.
- ... on a surface that is unstable or subject to vibration.

2. DO NOT block the recorder's ventilation openings or holes.

(If the ventilation openings or holes are blocked by a newspaper or cloth, etc., the heat may not be able to get out.)

3. DO NOT place heavy objects on the recorder or remote control.

4. DO NOT place anything which might spill on top of the recorder or remote control.

(If water or liquid is allowed to enter this equipment, fire or electric shock may be caused.)

5. DO NOT expose the apparatus to dripping or splashing.

6. DO NOT use this equipment in a bathroom or places with water. Also **DO NOT** place any containers filled with water or liquids (such as cosmetics or medicines, flower vases, potted plants, cups, etc.) on top of this unit.

7. DO NOT place any naked flame sources, such as lighted candles, on the apparatus.

8. AVOID violent shocks to the recorder during transport.

MOISTURE CONDENSATION

Moisture in the air will condense on the recorder when you move it from a cold place to a warm place, or under extremely humid conditions—just as water droplets form in the surface of a glass filled with cold liquid. Moisture condensation on the head drum will cause damage to the tape. In conditions where condensation may occur, keep the recorder turned on for a few hours to let the moisture dry.



- Cassettes marked “VHS” (or “S-VHS”) can be used with this video cassette recorder. However, S-VHS recording is not possible with this model.
- This model is equipped with SQPB (S-VHS QUASI PLAYBACK) that makes it possible to play back S-VHS recordings in the SP mode with regular VHS resolution.
- HQ VHS is compatible with existing VHS equipment.
- VIDEO Plus+ and PlusCode are registered trademarks of Gemstar Development Corporation. The VIDEO Plus+ system is manufactured under license from Gemstar Development Corporation.

Some Do's And Don'ts On The Safe Use Of Equipment

This equipment has been designed and manufactured to meet international safety standards but, like any electrical equipment, care must be taken if you are to obtain the best results and safety is to be assured.

- DO** read the operating instructions before you attempt to use the equipment.
- DO** ensure that all electrical connections (including the mains plug, extension leads and interconnections between pieces of equipment) are properly made and in accordance with the manufacturer's instructions. Switch off and withdraw the mains plug when making or changing connections.
- DO** consult your dealer if you are ever in doubt about the installation, operation or safety of your equipment.
- DO** be careful with glass panels or doors on equipment.
- DON'T** continue to operate the equipment if you are in any doubt about it working normally, or if it is damaged in any way — switch off, withdraw the mains plug and consult your dealer.
- DON'T** remove any fixed cover as this may expose dangerous voltages.
- DON'T** leave equipment switched on when it is unattended unless it is specifically stated that it is designed for unattended operation or has a standby mode. Switch off using the switch on the equipment and make sure that your family knows how to do this. Special arrangements may need to be made for infirm or handicapped people.
- DON'T** use equipment such as personal stereos or radios so that you are distracted from the requirements of road safety. It is illegal to watch television whilst driving.
- DON'T** listen to headphones at high volume, as such use can permanently damage your hearing.
- DON'T** obstruct the ventilation of the equipment, for example with curtains or soft furnishings. Overheating will cause damage and shorten the life of the equipment.
- DON'T** use makeshift stands and NEVER fix legs with wood screws — to ensure complete safety always fit the manufacturer's approved stand or legs with the fixings provided according to the instructions.
- DON'T** allow electrical equipment to be exposed to rain or moisture.

ABOVE ALL...

- **NEVER** let anyone especially children push anything into holes, slots or any other opening in the case — this could result in a fatal electrical shock;
- **NEVER** guess or take chances with electrical equipment of any kind — it is better to be safe than sorry!

Contents

Diagrams of Equipment	6
Equipment Key	7
Welcome to JVC	8
Three-Step Quick Start.....	10
Basic Features	13
Advanced Features	29
Subsidiary Information	57
List of Terms	61

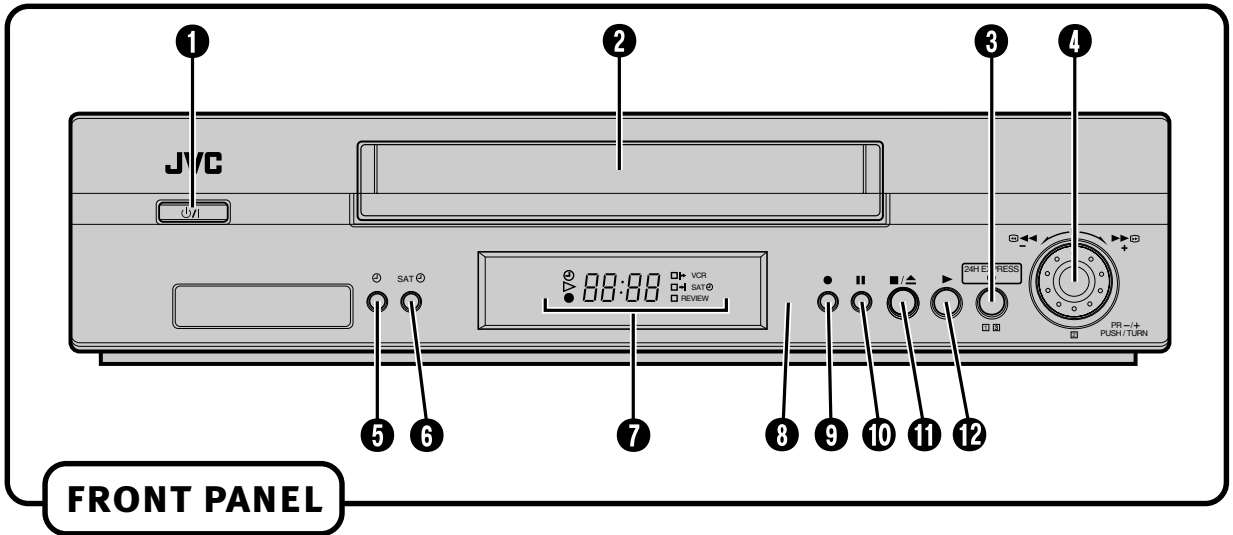

FRONT PANEL

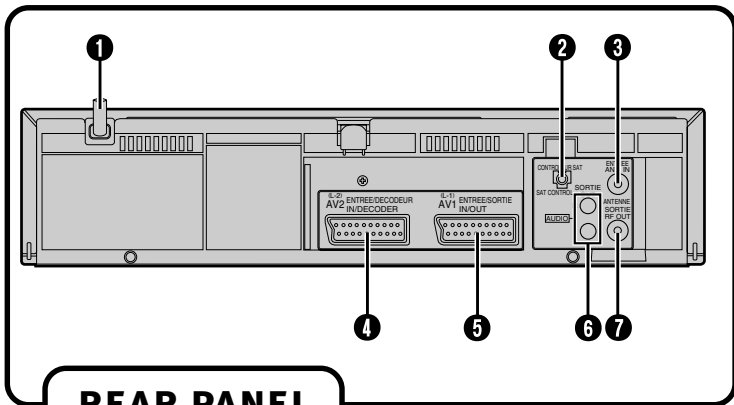

REAR PANEL

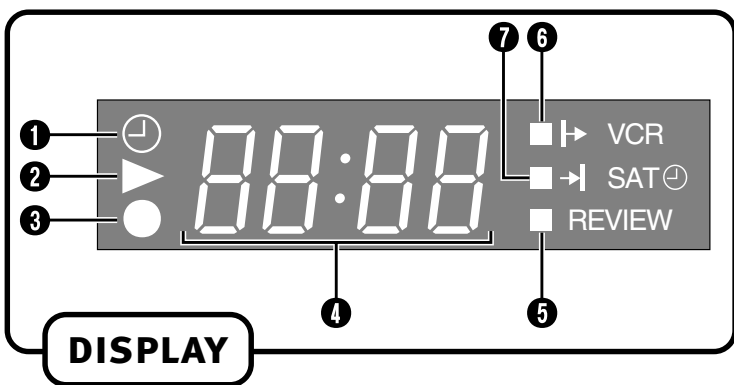



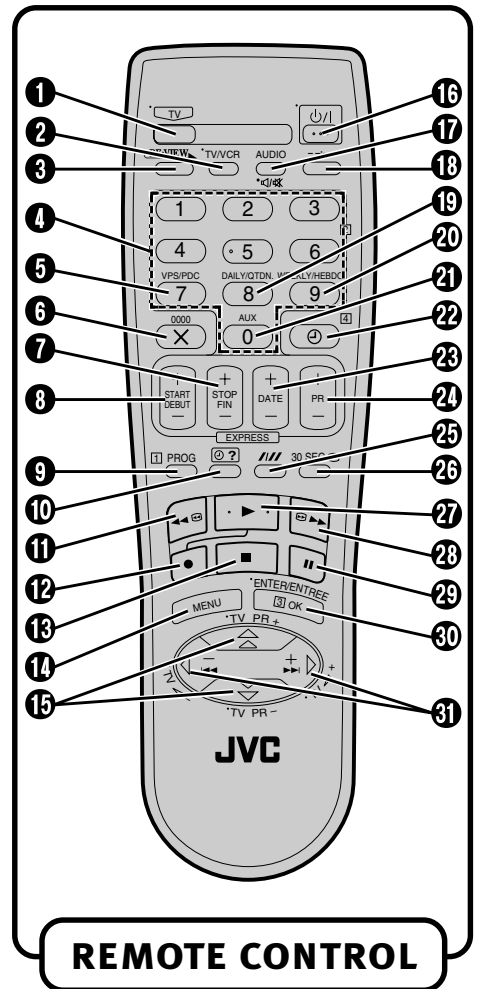





DISPLAY



REMOTE CONTROL

Diagram Key

FRONT PANEL



- 1 **STANDBY/ON**  Button turns VCR on/off (loading a cassette also turns power on).
- 2 **Cassette Loading Slot** is where cassette is inserted; door closes.
- 3 **24H EXPRESS**  Button enables 24H Express Timer Programming.
- 4 **Advanced JOG Dial** enables picture search, preset position selection or 24H Express Timer Programming.
- 5  Button engages timer standby mode.
- 6 **SAT**  Button enables/disables the Auto Satellite Programme Recording mode.
- 7 **Display Panel** provides clear view of various displays and indicators.
- 8 **Infrared Beam Receiving Window** is where Remote Control should be aimed when in use.
- 9  Button starts regular recording (press once), Instant Timer Recording (press twice); sets duration of ITR.
- 10  Button stops tape temporarily during recording; stops tape temporarily during playback; plays back frame by frame with each additional press.
- 11  Button stops tape; ejects tape during Stop mode.
- 12  Button plays back tape; cancels Pause, Still, Slow, Search modes.

REAR PANEL

- 1 **Mains Power Cord** supplies power to VCR.
- 2 **SAT CONTROL Connector** enables connection of the provided Satellite Controller for timer recording with a satellite receiver.
- 3 **ANT. IN Connector** enables connection of aerial.
- 4 **AV2 (L-2) IN/DECODER Connector** enables connection of satellite receiver or second recorder; input recordable when L-2 selected.

- 5 **AV1 (L-1) IN/OUT Connector** enables AV connection to TV or second VCR; input recordable when L-1 selected.
- 6 **AUDIO OUT (L/R) Connectors** enable connection of audio cassette recorder, TV or second VCR for dubbing.
- 7 **RF. OUT Connector** enables connection to aerial terminal of TV receiver.

VCR DISPLAY PANEL

- 1  Indicator lights when the  button has been pressed to engage Timer mode.
- 2 **Play Indicator** lights up during playback; blinks during Repeat Playback or when using Next Function Memory for playback.
- 3 **Record Indicator** lights up during recording; blinks during Instant Timer Recording.
- 4 **Channel Display** shows preset position where the station currently being received is stored.

Mode shows external input mode selected (L-1, L-2 or SAT).

Clock Display shows current time.

Preset Position* (or Mode) and Clock Display appear alternately when  is pressed.

* *Preset Position (or Mode) is not displayed during playback.*







- 5 **REVIEW Indicator** blinks after timer-recording and shows how many programmes have been timer-recorded.
- 6 **Programme Start Time Indicator** shows the programme start time for 24H Express Timer Programming.

VCR Indicator lights when the VCR is in the video mode. At this point, the TV automatically enters AV mode.

- 7 **Programme Stop Time Indicator** shows the programme stop time for 24H Express Timer Programming.

SAT  Indicator lights up during Auto Satellite Programme Recording standby mode; blinks when Auto Satellite Programme Recording is in progress.

REMOTE CONTROL

- 1 **TV Button** enables Remote Control of your JVC TV.
- 2 **TV/VCR Button** switches connected TV's mode between TV and AV.
- 3 **REVIEW**  Button 'reviews' timer-recorded programme.
- 4 **Number Keys** are used in preset position selection and the VIDEO Plus+ Timer Programming.
- 5 **PDC Button** enables/disables PDC recording.
* *VPS (Video Programme System) recording is not currently available in the U.K. and not possible with this VCR.*
- 6 **X Button** cancels timer-programme.
oooo Button resets counter on the on-screen display to '0:00:00'.
- 7 **STOP +/- Button** inputs programme Stop Time.
- 8 **START +/- Button** accesses Regular Program screen; inputs programme Start Time.
- 9 **PROG Button** accesses VIDEO Plus+ Program screen.
- 10  Button accesses Program screens/displays to check the programme that you have programmed (next programme's information screen appears each time button is pressed).
- 11  Button rewinds the tape; initiates high-speed reverse search.
- 12  Button — same as button on VCR.
- 13  Button stops tape.
- 14  Button accesses Menu screen.

- 15   Buttons are used for selection in on-screen menus.

TV PR +/- Buttons selects the connected JVC TV's channel.

- 16 **STANDBY/ON**  Button — same as button on VCR.

- 17 **AUDIO Button** changes output sound mode.

 **(TV Muting) Button** mutes sound of connected JVC TV.

- 18  **(Display) Button** switches display between clock time and Preset Position* (or Mode).

* *Preset Position (or Mode) is not displayed during playback.*

- 19 **DAILY Button** enables timer recording of daily serials.

- 20 **WEEKLY Button** enables timer recording of weekly serials.

- 21 **AUX Button** selects VCR's auxiliary input mode.

- 22  Button engages timer-standby mode.

- 23 **DATE +/- Button** inputs date of programme for timer recording.

- 24 **PR +/- Button** selects a preset position.

- 25 **Auto Tracking Button** enables/disables auto tracking mode during playback.

 Button selects tape speed.





- 26 **30 SEC**  Button initiates a 30-second period of fast-motion playback.



- 27  Button — same as button on VCR.

- 28  Button fast-forwards tape; initiates high-speed forward search.

- 29  Button — same as button on VCR.

- 30  Button enters selections made in on-screen menus.

31      Buttons initiate functions such as Index Search, variable-speed search, frame by frame playback.

TV   Buttons control volume of connected JVC TV.

Welcome to JVC

Thank you for choosing JVC.

We hope that you will get many hours of enjoyment from your new unit.

In just three easy steps you will be ready to enjoy the exceptional performance of your new VCR. More detailed instructions begin on page 10. They will explain how to use the many sophisticated features this VCR boasts.



Getting Everything Ready

BEFORE YOU START

Please read the **SAFETY FIRST** on pages 2–4 it tells you about some safety points

Refer to the diagrams on pages 6–7 when reading through these instructions

Refer to the **List of Terms** on page 61 if you need an explanation for any terms in this manual

CHECK THE CONTENTS Unpack the box and place the VCR on a flat, stable surface. Check that you have the items shown below.

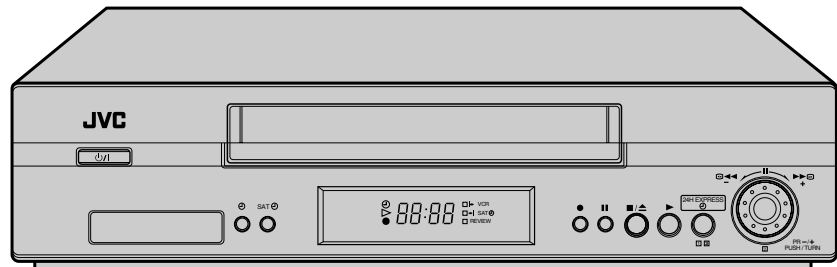

Video Cassette Recorder



Satellite Controller

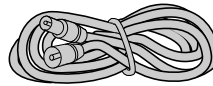

RF Cable

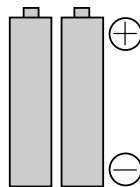

AA Batteries x 2

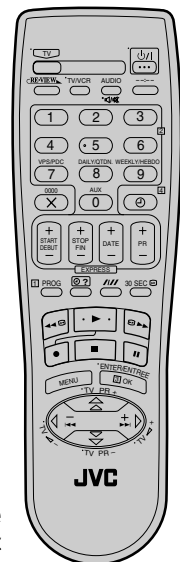

Infrared Remote Control Unit

GETTING EVERYTHING READY (continued)

CONNECT CABLES Connect the cables as indicated in the diagram (below), using the TV Aerial Cable, the RF Cable and the 21-pin SCART Cable (not provided).

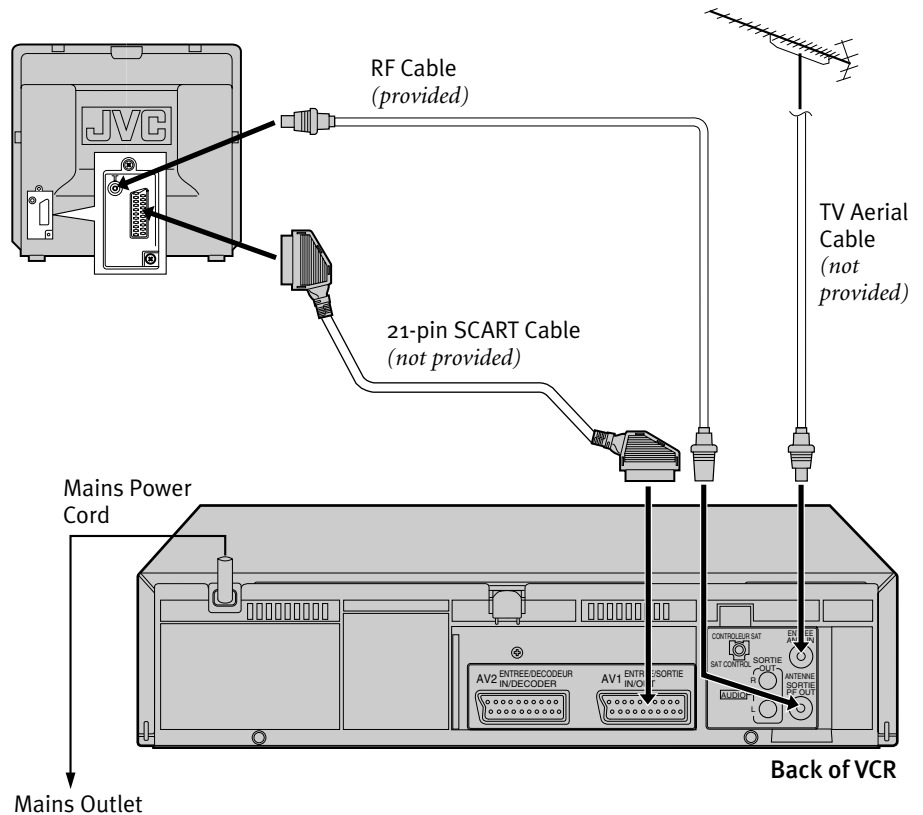
**SCART AND RF**

SCART is a recommended option because its use improves the quality of the picture. If connecting to a stereo TV you will need a SCART cable. There are several types of SCART cables, fully-wired and others.

If you use a SCART cable, you must also connect the RF cable.

You are now ready to start the Three-Step Quick Start which begins on the next page.

You have two ways for initial setup of your new VCR depending upon the connection method and your TV.

If you have connected only the RF cable,
perform *Auto Setup* (➔ pg. 10).

If you have connected both the RF cable and the fully-wired 21-pin SCART cable, and if your TV offers T-V Link, etc.*,
perform *Preset Download* (➔ pg. 11).

* Compatible with TVs offering T-V Link, EasyLink, Megalogic, SMARTLINK, Q-Link, DATA LOGIC or NexTVView Link via fully-wired 21-pin SCART cable. The degree of compatibility and available functions may differ by system.

Three-Step Quick Start

– Auto Setup and Preset Download

1 2 3

Auto Setup

BEFORE YOU START

Check that the VCR is turned off and no cassette is inserted

Load the batteries into the Remote Control

Refer to the Remote Control diagram on pages 6–7

Unless indicated otherwise, use the buttons on the Remote Control

Check that the connection is completed

Turn on the TV

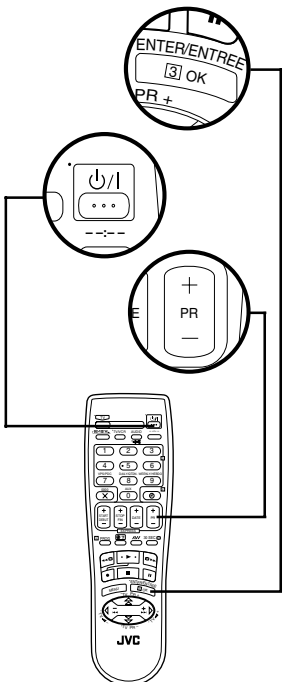

START AUTO SETUP

Press the button. If 'Auto' appears on the display panel, press **OK** (or).

WHAT WILL HAPPEN? The display panel on the front of the VCR will show the word 'Auto'. Do not press any button on the VCR or the Remote Control.

NOTE If you have connected both the RF cable and the fully-wired 21-pin SCART cable, and if your TV offers T-V Link, etc., and the TV is turned on, the VCR automatically performs the Preset Download (see pg. 11) even if you select 'Auto' for Auto Setup function.



Auto Setup is running: don't touch any buttons

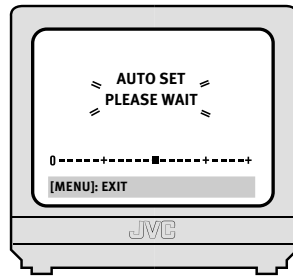

Your TV screen during Auto Setup if SCART is used

The VCR is automatically setting up the tuner channels, clock, the VIDEO Plus+ assigned Guide Program numbers and the video channel. This only happens the first time that the VCR is turned on.

RF AND SCART CONNECTION If you have chosen to connect the VCR to the TV with both the RF Cable and a 21-pin SCART Cable (*not included*) and the TV set is in its AV mode (see the TV manual), you will see the following information displayed on your TV screen:

SELECT THE VIDEO CHANNEL

When Auto Setup has finished, 'SCAN COMPLETED' appears on the TV screen. You will see the following display panel on your VCR:

RF CABLE ONLY If you have only used the RF Cable to connect the VCR to the TV, you will see this display. The number is the channel on the TV that the Auto Setup has chosen to be the video channel.



RF AND SCART CONNECTION If you have chosen to connect the VCR to the TV with both the RF Cable and a 21-pin SCART Cable (*not provided*), you need to press the **PR** button on the Remote Control until the figure reads '—'. This is because you will use the TV in AV mode to view video pictures and therefore do not need a dedicated video channel.

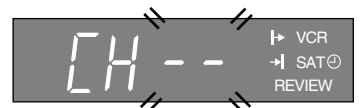

FINISH AUTO SETUP

Press and move on to **Step 2** to check the results.

oops! If there is a power cut or you accidentally press a button during **Auto Setup**, turn the VCR off and then on again. Re-perform **Auto Setup**.

1 2 3 **Preset Download**

BEFORE YOU START

Check that the VCR is turned off and no cassette is inserted

Load the batteries into the Remote Control

Refer to the Remote Control diagram on pages 6-7

Unless indicated otherwise, use the buttons on the Remote Control

Check that the connection is completed

Be sure to use the fully-wired 21-pin SCART cable

Turn on the TV

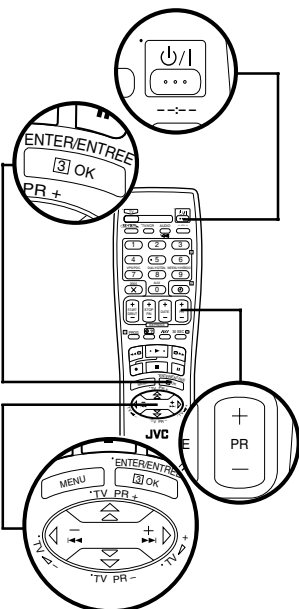

START PRESET DOWNLOAD

Press the button. The display panel on the front of the VCR will show the word 'Auto'. Press the and buttons to select 'CH --' and press **OK** (or).

WHAT WILL HAPPEN? The VCR is automatically setting up the tuner channels by downloading from your TV, clock and the VIDEO Plus+ assigned Guide Program numbers. During downloading, preset position on the display panel increases from "CH1".

RF AND SCART CONNECTION If the TV set is in its AV mode (see the TV manual), you will see the following information displayed on your TV screen:

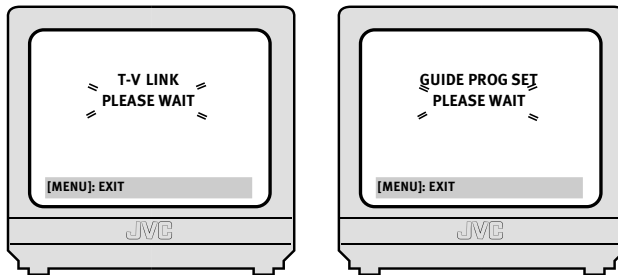

Your TV screen during Preset Download



Preset Download is running: don't touch any buttons

SET THE VIDEO CHANNEL TO OFF

When **Preset Download** has finished, 'COMPLETED' appears on the TV screen. Press to turn off the VCR. Press and hold down on the VCR until you will see the display on the right. Press **PR** Button on the Remote Control until the figure reads ' -- '.



FINISH PRESET DOWNLOAD

Press and move on to **Step 2** to check the results.

oops! If there is a power cut or you accidentally press a button during **Preset Download**, turn the VCR off and then on again. Re-perform **Preset Download**.

NOTES

- In areas where no TV station transmits the PDC signal, the VCR cannot setup either the clock or Guide Program numbers.
- On this VCR, the characters available for station names (ID) are A-Z, 0-9, -, *, + and _ (space). The names of some downloaded stations may differ from those on your TV.

1 2 3

Check the Results

When **Auto Setup** or **Preset Download** finishes, you will see one of the three following examples on the VCR display panel:



The Preset Positions and the Clock have been set successfully

Go straight to **Step 3** (20:00 used as example only).



The Preset Positions have been set successfully but the Clock has not

Perform **Clock Set** on page 55.

Go to **Step 3**.



Neither the Preset Positions or the Clock have been set successfully

Make sure the cables are connected properly to the VCR and turn the VCR off and then on again. Try **Auto Set Up** or **Preset Download** again.

1 2 3

Finish Off

Select the Video channel or AV mode, then make sure that all necessary stations have been stored in the VCR's memory by using the and buttons. If station names (ID — [pg. 53](#)) have also been stored in the VCR's memory, the station name will be displayed at the top left corner of the TV screen for about 5 seconds each time you select a different channel via the VCR.

The VCR is now set up. You can now use it to play and record.

IMPORTANT

- **RE-RUNNING SETUP** Auto Setup or Preset Download may not behave as described if it has already been run on the VCR. This is because some of the information gathered on the first Auto Setup or Preset Download is retained in memory and that part of the process may be skipped by the VCR.
- **BAD RECEPTION** In certain reception conditions, station names may not be stored correctly, and **Guide Program Numbers** may not be set properly. If this happens, when you timer-record a TV programme using the VIDEO Plus+ system, the VCR will record a TV programme of a different station. When programming the timer using the VIDEO Plus+ system, be sure to check that the preset position corresponding to the broadcasting station you wish to record has been selected ([pg. 21](#), **VIDEO Plus+ Timer Programming**).
- **DUPLICATE STATIONS** You may be able to receive the same station from two different transmitters in which case Auto Setup will detect and store both. It is normal for one transmitter to give you a better quality picture than the other; to delete those stations which have a poor picture [Delete A Channel](#) on page 51.
- **MANUAL STATION SETTING** If any of the above problems occur, refer to pages 51 – 52 to input station names ([Set Stations](#)). You can also change station preset positions ([Change Station Preset Position](#)).
- **RF CONNECTIONS** In certain reception conditions, the Video Channel may not be set correctly and interference may appear in the TV picture while the VCR's power is on. Set your Video Channel manually. ([pg. 48](#), **Video Channel Set**)

IF YOU HAVE ANY DIFFICULTY WITH THE ABOVE PROCEDURES CALL THE JVC CUSTOMER SERVICE HOT LINE ON 0870 330 5000

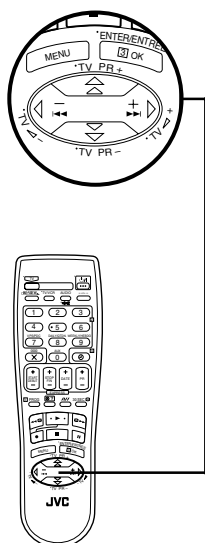

Basic Features

Playback.....	14
Playback Features	16
Recording	18
VIDEO Plus+® Timer Programming	21
Express Timer Programming	24
24H Express Timer Programming	26

Playback

Playback is the most basic operation possible with your VCR. Audio-visual information recorded on a cassette will be played back on your TV screen just like a broadcast programme.

1 Load a Video Cassette

BEFORE YOU START

Turn the TV on

Tune the TV to your Video Channel or to its AV mode

NTSC TAPES

If an NTSC tape is played, 'NTSC→PAL' appears on screen for about 5 seconds

Some TVs will shrink the picture and place black bars at the top and bottom of the screen. This is not a malfunction but you may lose some on-screen information

The picture may roll up or down. Correct this by adjusting the vertical hold on the TV set

The counter and tape remaining times will be incorrect

The picture will be distorted during search, still or frame-by-frame playback

Make sure that the window side of the cassette is facing up and the spine label is facing away from the VCR. Insert the cassette as shown in the diagram below; don't use too much force. If the VCR was turned off before you inserted the cassette, the power will come on automatically.

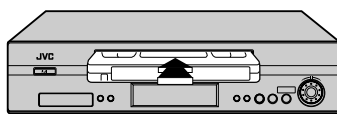

The counter on the TV screen will reset to read '0:00:00'. If the record safety tab on the video cassette has been removed, playback begins automatically.

2 Play

If the cassette that you inserted does not start playing automatically, press the ► button on the VCR or the Remote Control. 'bEST' appears blinking in the display panel during automatic tracking (☞ pg. 31).

3 Stop & Eject

STOP Press the ■/▲ button on the VCR or the ■ button on the Remote Control once to stop playback.

EJECT Press the ■/▲ button on the VCR a second time to eject the cassette from the VCR. The cassette will take about 6 seconds to appear once the ■/▲ button has been pressed.

4 Rewind and Fast Forward

REWIND Press the  button on the Remote Control or turn the **JOG Dial** to the left.

FAST FORWARD Press the  button on the Remote Control or turn the **JOG Dial** to the right.

* SQPB

This VCR is equipped with SQPB (S-VHS QUASI PLAYBACK) that lets you watch tapes recorded in the S-VHS format and the SP mode, with regular VHS resolution.

NOTES:

- SQPB does not deliver Super VHS resolution.
- S-VHS recording is not possible with this VCR.
- When you play back a tape recorded in S-VHS format and the SP mode, noise may appear in the still, slow motion, or frame-by-frame playback mode.
- Depending on the tape, noise may appear during normal playback.

* Video Heads Cleaning

Use a dry cleaning cassette — JVC TCL-2U — in the following cases:

- Rough, poor picture appears while a tape is played back.
- The picture is unclear or no picture appears.
- 'USE CLEANING CASSETTE' appears on the screen (only with 'O.S.D.' set to 'ON' ( pg. 44)).

Playback Features



Advanced JOG Dial

The **JOG Dial** can be found on the front right of the VCR. It has various functions, such as picture search (☞ this page and pg. 17), selecting preset position (☞ pg. 18), 24H Express Timer Programming (☞ pg. 26), etc.



1 Pause During Playback

There are two ways to view a still picture during playback:

METHOD ONE Push the center part of the **JOG Dial**.

METHOD TWO Press the **||** button on the VCR or the Remote Control.

- If the paused picture on the TV screen jumps vertically, press the **PR** button on the Remote Control until the picture is steady.
- Press **▶** to resume playback.



2 Single Frame Movement

You can move backward or forward from the still picture in one of three ways:

METHOD ONE Turn the **JOG Dial** right for forward or left for back.

METHOD TWO Press the **||** button on the Remote Control. Each time the **||** button is pressed, the frame will move forward one frame.

METHOD THREE Press **◀**, **⏮** or **⏭**, **▶** on the Remote Control. Each time one of these buttons is pressed, the frame will advance or move back one frame.

- Press **▶** to resume playback.

3 Slow Motion

This VCR will play your cassette forwards or backwards in slow motion. You can make it do this in one of three ways:

METHOD ONE During playback, turn the **JOG Dial** to the right for forwards slow motion, or to the left for reverse slow motion.

METHOD TWO During still picture, press and hold **||** on the Remote Control for 2 seconds, then release. Press and release **||** again to return to still picture.

METHOD THREE During still picture, press and hold the **◀** or **▶** button on the Remote Control. The picture will return to still when you release the button.

- If the slow motion picture on the TV screen jumps vertically, press the **PR** button on the Remote Control until the picture is steady.
- Press **▶** to resume playback.

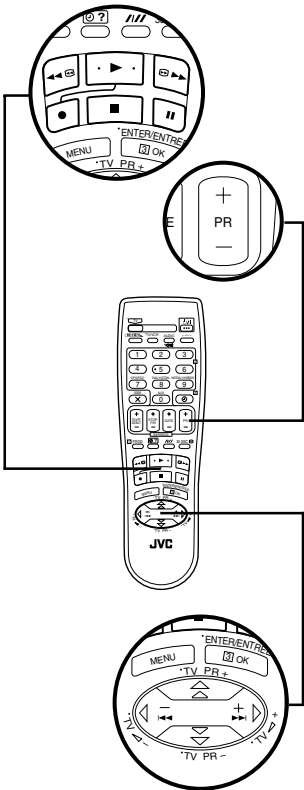

4 Variable Speed Search

You can use variable speed search with one of two methods:

METHOD ONE During playback, turn the **JOG Dial**. The speed forward or reverse depends upon the number of click stops of the **JOG Dial**.

METHOD TWO During playback, press the **◀** or **▶** button on the Remote Control. The more times that you press either button, the faster the rate of search. To decrease the speed of search, press the button for the opposite direction.

- Press **▶** to resume playback.

5 High Speed Search

You can perform a high speed search in either direction using the **JOG Dial** or the Remote Control.

JOG DIAL During playback, turn the **JOG Dial** to the right (for forward search) or left (for reverse search).

REMOTE CONTROL During playback or still picture, press the **▶▶▶▶** on the Remote Control for forward high speed search, or the **◀◀◀◀** button for reverse high speed search. If either button is pressed for more than 2 seconds, normal playback will resume the moment you release the button.

- Press **▶** to resume playback.

Recording

TV signals being received by the recorder's built in tuner can be recorded onto a video tape. You can 'capture' a TV programme using your VCR.

1

Choose a Programme

BEFORE YOU START

Turn the TV on

Tune the TV to your Video Channel or to its AV mode

Choose a blank cassette which has the record safety tab still in place

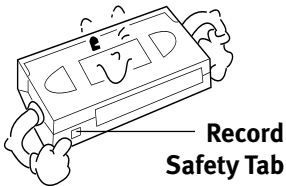

Load the cassette into the VCR (see page 14)

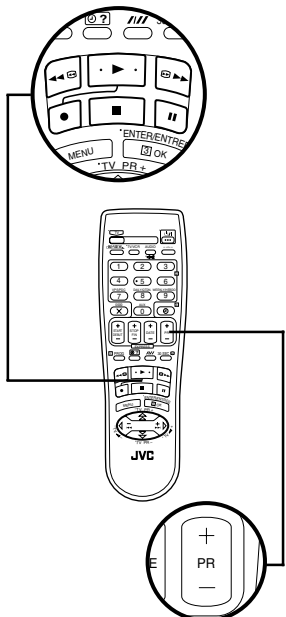

There are two ways to select a preset position of the VCR.

METHOD ONE Press **PR +/-** or the number keys on the Remote Control to select the channel that you wish to record.

METHOD TWO Push the center part of the **JOG Dial** so that the preset position appears on the TV screen. While the display is shown, turn the **JOG Dial** to the right or left.

2

Set the Tape Speed

Press **///** and check the on-screen display until the required tape speed is shown. You can choose between Long Play (LP) or Short Play (SP). The picture quality on LP recordings will not be as high as on SP recordings, but the tape will last longer.

3

Start Recording

There are two ways to start recording:

METHOD ONE Press and hold ● and then press ► on the Remote Control.

METHOD TWO Press ● on the VCR.

4

Pause and Resume During Recording

On either the VCR or the Remote Control, press **||** to temporarily stop recording and press **►** to resume. You cannot change the preset position on the VCR while it is recording but you can while it is paused (*see Choose a Programme at the top of this page*).

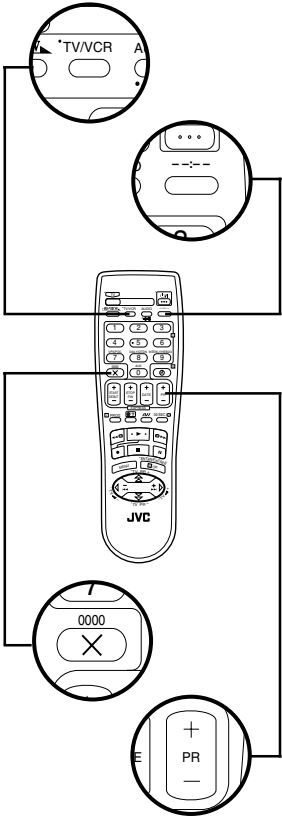

! Notes on Recording

When using both the RF and SCART connections, you can switch between TV and VCR by pressing the TV/VCR button on the Remote Control.

* Display Tape Remaining Time

Press the ---:-- button so that the tape remaining time is shown on the TV screen with 'REMAIN' indication. The on-screen information will disappear after about 5 seconds.

NON-STANDARD TAPES Sometimes, a tape will not conform to the standards accepted by this VCR. In such cases the tape remaining time may not appear immediately, be incorrect or simply show as '---:--'.

* Change Display Information

By pressing the ---:-- button repeatedly, you can change the display on the VCR between the clock time and the preset position. The preset position cannot be shown during playback.

* Resetting the Counter

Press the ---:-- button so that the counter display appears on the TV screen. While the display is shown, press the 0000 button. You can reset the counter to '0:00:00' before starting playback or recording.

* Record a Programme While Watching Another

Once you have started recording all you need to do is use the controls on your TV set to tune to a different programme. The programme set using the PR button on the Remote Control is the one which will be recorded.



Recording Resume Function

If there is a power cut during recording (or Instant Timer Recording or timer recording), the recording will resume automatically when power is restored to the VCR unless the VCR's memory backup has expired.



Instant Timer Recording

This method allows you to quickly set the VCR to record in 30 minute increments.

START RECORDING Press ● on the VCR once. If left in this state, the VCR will keep recording until the tape runs out.

ENGAGE INSTANT TIMER RECORDING Press ● again and the display panel will show a flashing Record indicator (○) and '0:30'. This means that the VCR will record for 30 minutes on the programme already selected and then stop automatically.

INCREASE TIME Each time ● is pressed, the time limit is increased by 30 minutes to a maximum of 6 hours.

This function only works with the ● button on the VCR, not the Remote Control.

VIDEO Plus +[®]

Timer Programming

BEFORE YOU START

Make sure that the VCR's clock is set correctly

Insert a cassette with the safety tab in place

Turn on the TV and select the Video channel or the AV Mode

The VIDEO Plus+ system uses the code numbers – called PlusCodes – printed after each programme in your TV listings guide. These are a kind of shorthand for video recorders and using them automatically sets your VCR to record the correct programme, channel and time.

1 Get to the VIDEO Plus + Screen

Press **1**PROG. You will see the following TV screen information.

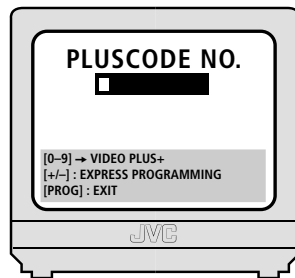

2 Enter the PlusCode Number

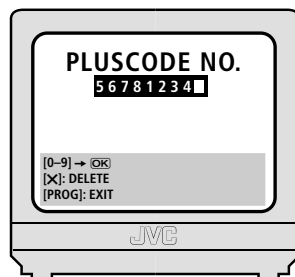
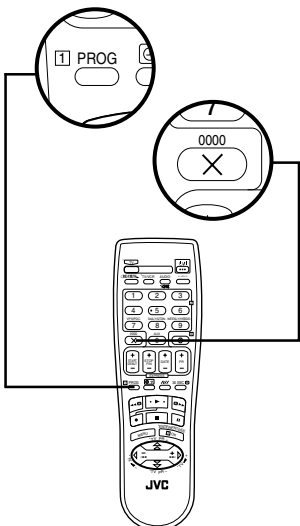

Press the number keys on the Remote Control to enter the PlusCode of the programme you wish to record. If you make a mistake, press **X** to delete the incorrect number and then enter the correct one.

ERRORS If the PlusCode you entered is invalid, **ERROR** appears on the TV screen.

3 Check the Results

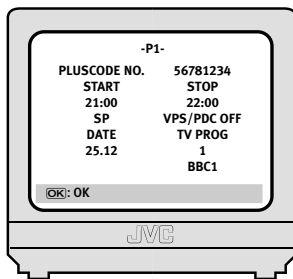
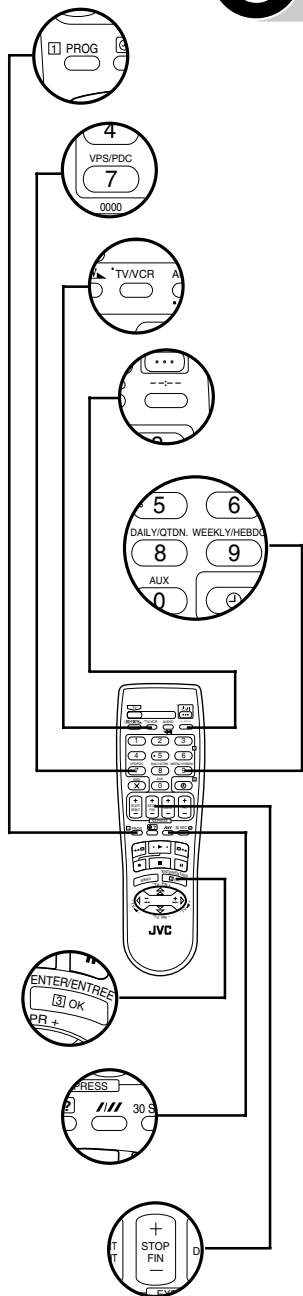

Press . The VIDEO Plus+ Program screen appears.

Make sure that the preset number displayed is the one that you want. If it is incorrect, the wrong programme will be recorded. If it is incorrect see the section titled **Guide Program Numbers**. (pg. 56)

SET TAPE SPEED You can change the tape speed between short play (SP) and long play (LP) by pressing .

SET PDC MODE Press PDC to change between ON and OFF. Programme Delivery Control (PDC) is a service designed to ensure that timer recording still works in the event of a change in time of broadcast. If you set PDC to ON, your VCR will be turned on not by its own timer but by a signal transmitted by the broadcaster. This means that if an advertised programme is delayed, your VCR will still record it properly.

CHANGE STOP TIME Press STOP +/- . You can compensate for anticipated changes in schedule using this method.

SERIAL RECORDING To set the VCR to record the same programme on a daily or weekly basis, press WEEKLY (number key 9) or DAILY (number key 8) to turn the function on. Pressing the same key again turns the function off. You will see your selection appear on the TV screen.

CAPACITY You can set this VCR to timer record up to eight programmes. If you try enter a ninth, PROGRAM FULL appears on the screen.



SATELLITE RECEIVER USERS To timer-record a satellite broadcast using the VIDEO Plus+ system:



- Perform 'Satellite Receiver Control Setting' (pg. 36).
- You cannot set PDC to ON.
- You cannot timer-record the satellite broadcast received on the channel position '0' by the satellite receiver.
- Leave the satellite receiver's power on.

4 Return to Normal Screen

Press or . PROGRAM COMPLETED appears on the TV screen for about 5 seconds, then the normal TV screen appears. If the timer programme is overlapped with another one that was already set, PROGRAM OVERLAPPED appears on the TV screen. (pg. 28)

5 Engage Timer Mode

You must now put the VCR into Timer Mode by pressing  otherwise no recording will take place.  will appear on the display panel. To disengage the Timer Mode, press  again.

If no video tape is loaded or the safety tab is removed, , Play indicator () and Record indicator () will flash. Insert a tape to record!

If you have set the VCR to Timer Record a programme and have not engaged the Timer Mode, you will see this warning appear on your screen five minutes before the appointed start time. To clear the display, press .

WARNING If the VCR is being used as the player for tape-to-tape dubbing, this warning screen will be recorded by the other VCR.

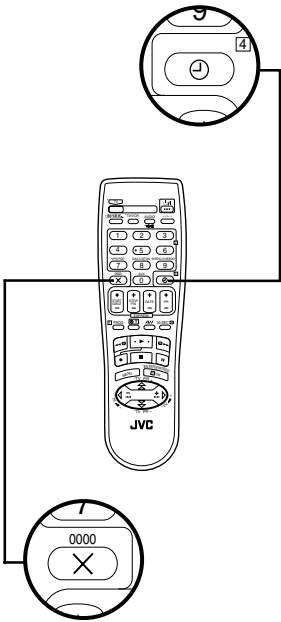

Express Timer Programming

BEFORE YOU START

Make sure that the VCR's clock is set correctly

Insert a cassette with the safety tab in place

Turn on the TV and select the Video channel or the AV Mode

If you do not know the PlusCode for the programme that you wish to record, follow the instructions below to manually set your VCR to record.

1 Get to the Programme Screen

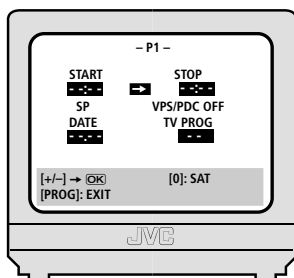

Press **PROG** then press **START +/-**.

2 Enter Programme Details

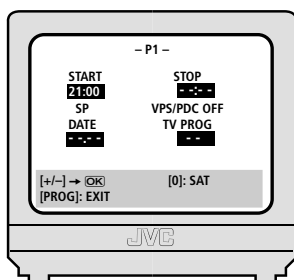

SET START TIME Use the **START +/-** button to enter the start time.



SET STOP TIME Use the **STOP +/-** button to enter the stop time.



SET DATE Use the **DATE +/-** button to adjust the date (current date will automatically appear).



SET PROGRAMME Use the **PR +/-** button to enter the programme required.

SET TAPE SPEED You can change the tape speed between short play (SP) and long play (LP) by pressing **///**.

SET PDC MODE Press **PDC** to change between **ON** and **OFF**. Programme Delivery Control (PDC) is a service designed to ensure that timer recording still works in the event of a change in time of broadcast. If you set **PDC** to **ON**, your VCR will be turned on not by its own timer but by a signal transmitted by the broadcaster. This means that if an advertised programme is delayed, your VCR will still record it properly.

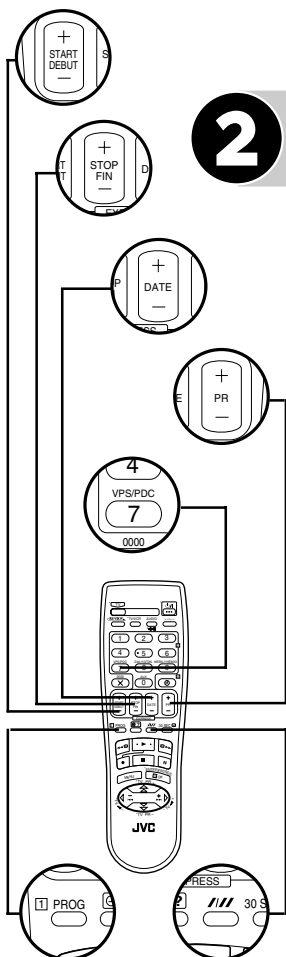

SATELLITE RECEIVER USERS To timer-record a satellite broadcast using Express Timer Programming:

- Perform 'Satellite Receiver Control Setting' (☞ pg. 36).
- Press **AUX** (number key **0**) to change **TV PROG** to **SAT**. Then press **PR +/-** to enter the preset position for the satellite receiver.
- You cannot set **PDC** to **ON**.
- You cannot timer-record the satellite broadcast received on the channel position '0' by the satellite receiver.
- Leave the satellite receiver's power on.

For memory capacity and Serial Programming, see **VIDEO Plus+ Timer Programming** on page 21.

3 Return to Normal Screen

Press **PROG** or **OK**. **PROGRAM COMPLETED** appears on the TV screen for about 5 seconds, then the normal TV screen appears. If the timer programme is overlapped with another one that was already set, **PROGRAM OVERLAPPED** appears on the TV screen. (☞ pg. 28)

4 Engage Timer Mode

You must now put the VCR into Timer Mode by pressing **⊖** otherwise no recording will take place. **⊖** will appear on the display panel. To disengage the Timer Mode, press **⊖** again.

If no video tape is loaded or the safety tab is removed, **⊖**, Play indicator (**▷**) and Record indicator (**○**) will flash. Insert a tape to record!



If you have set the VCR to Timer Record a programme and have not engaged the Timer Mode, you will see this warning appear on your screen five minutes before the appointed start time. To clear the display, press **X**.

WARNING If the VCR is being used as the player for tape-to-tape dubbing, this warning screen will be recorded by the other VCR.

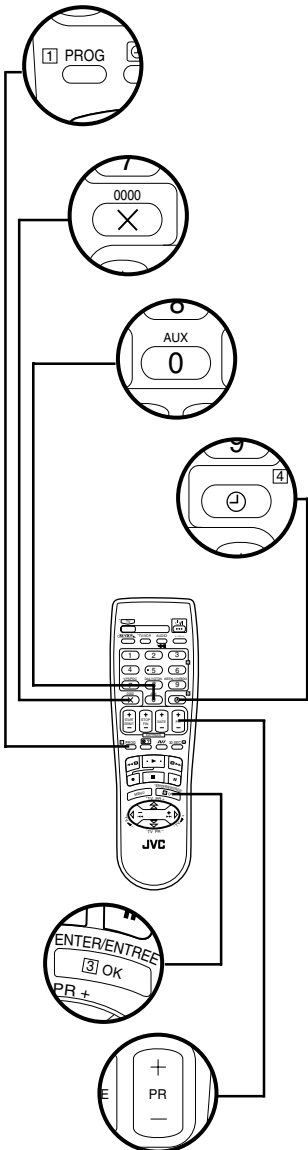

24H Express Timer Programming

You can program a timer recording that starts within 24 hours using the 24H EXPRESS ⊖ button and the Advanced JOG Dial on the VCR.

BEFORE YOU START

Set the tape speed

Make sure that the VCR's clock is set correctly

Insert a cassette with the safety tab in place

Turn on the TV and select the Video channel or the AV Mode

ENTER PROGRAM MODE Press the 24H EXPRESS ⊖ button on the VCR. The Programme Start Time indicator starts blinking on the display panel.



SET START TIME Turn the JOG Dial to the right or left. One click stop of the JOG Dial changes the time in 5-minute intervals.



SET STOP TIME Push the center part of the JOG Dial. The Programme Stop Time indicator starts blinking on the display panel. Turn the JOG Dial to the right or left.



SET PRESET POSITION Push the center part of the JOG Dial. Turn the JOG Dial to the right or left.

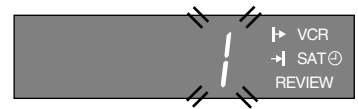

ENGAGE TIMER MODE Press the 24H EXPRESS ⊖ button on the VCR. The VCR turns off automatically and ⊖ is displayed on the display panel.

- Before pressing the 24H EXPRESS ⊖ button to engage the timer mode, you can cancel the setting at anytime by pressing the center part of the JOG Dial for more than 3 seconds. Repeat the above steps from setting the start time.



Notes

- You can set this VCR to timer record up to eight programmes. If you try enter a ninth, **FULL** appears on the display panel.
- If **Err** appears on the display panel, repeat the above steps again.
- When a menu screen is shown, you cannot use the 24H Express Timer Programming function. Press **MENU** to return to normal screen, and try again.
- You can use the 24H Express Timer Programming function also when the VCR is turned off.
- For the 24H Express Timer Programming function, the program overlap warning display does not appear even if some programmes overlap each other.



Check, Cancel & Change Programmes

Press \odot , then press $\odot/|$ to disengage the timer mode.

REVIEW THE PROGRAMMES Press \blacksquare . The TV screen will display a list of the programmes set for timer recording (screen A).

Pressing \blacksquare again will cycle through each of the entries in the VCR's memory (screen B).

CANCEL A PROGRAMME Press \times to cancel a programme.

CHANGE A PROGRAMME Use the **START +/-**, **STOP +/-**, **DATE +/-**, **PR +/-**, **///** and **PDC** buttons as necessary.

RETURN TO NORMAL SCREEN Press \blacksquare as many times as necessary.

RETURN TO TIMER MODE If there are still programmes to be recorded, press \odot .

	START	STOP	CH	DATE
1	8:00	10:00	3	24.12
2	10:00	10:45	2	25.12
3	11:30	13:00	1	25.12
4				
5				
6				
7				
8				

Screen A

- P1 -	
START	STOP
8:00	10:00
SP	VPS/PDC OFF
DATE	TV PROG
24.12	3
	ITV

Screen B







When Programmes Overlap Each Other

If **PROGRAM OVERLAPPED** appears, you have another programme overlapping the programme you have just made.

CONFIRM OVERLAPPING PROGRAMMES The Program Check screen appears and conflicting programmes will start blinking.

Example: Programme 1 (you have just made) and Programme 4 overlap each other.

SELECT PROGRAMME TO MODIFY Press the  and  buttons, then press **OK** (or  ). You can only select one of the overlapping programmes.

NOTE If you do not mind this overlap, press **PROG** to finish the timer programme setting. The programme with the lower programme number will be recorded and the other one will not be recorded correctly. Without doing anything for about 1 minutes, the VCR will finish the timer programming.

CANCEL A PROGRAMME Press **X** to cancel a programme when the Program screen you do not want is shown.

CHANGE A PROGRAMME Use the **START +/-**, **STOP +/-**, **DATE +/-**, **PR +/-**, **///** and **PDC** buttons as necessary, then press **OK**.

PROGRAM COMPLETED appears on the screen for about 5 seconds, then normal screen appears.

NOTE If the overlap is not yet solved or another overlap occurs with the timer programme setting made last after making correction on a programme, the conflicting programmes will be shown on the Program Check screen again. Repeat the above steps again until the overlap is solved.

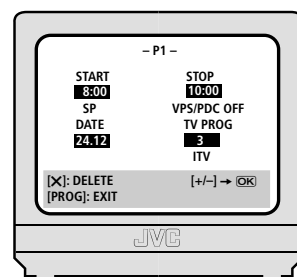
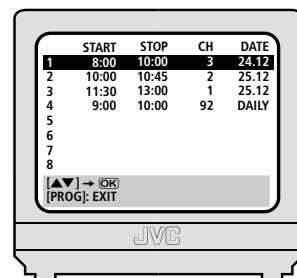

Advanced Features

Picture Quality	30
The B.E.S.T. Picture System	31
Sound Modes	32
Finding Specific Scenes	33
T-V Link Functions.....	34
Satellite Receiver Control Settings	36
Auto Satellite Programme Recording	39
Editing.....	41
Other Functions	44
Connection to a Stereo System	47
Video Channel Set	48
Tuner Set	49
Clock Set	55
Guide Program Numbers	56

Picture Quality



Manual Tracking

Your VCR is equipped with automatic tracking control. This will be adequate for most tapes and will automatically adjust the tracking to suit the particular tape in use but if you insert an old or worn tape, it may be necessary to manually adjust the tracking in order to get the best picture. If automatic tracking fails, you will notice noise bars appearing across the picture; you can correct this by manually overriding the tracking using the following steps.

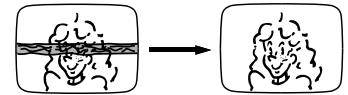

OVERRIDE AUTOMATIC TRACKING Press **///** on the Remote Control to engage manual tracking.

ADJUST TRACKING MANUALLY Use the **PR +** or **-** buttons to adjust the tracking manually.

NOTES:

- Press **///** again to re-engage automatic tracking.
- When a new tape is inserted, the VCR returns to automatic tracking.



Picture Control

This feature allows you to select the most appropriate picture quality according to the type of tape or use of this VCR. The default setting is **AUTO**.

GET TO THE MODE SET SCREEN Press **MENU**. Move the highlight bar to **MODE SET** using the **▲** and **▼** buttons and press **OK** (or **▶▶** **▶**).

SELECT PICTURE CONTROL MODE Move the highlight bar to **PICTURE CONTROL** using the **▲** and **▼** buttons. Press **OK** (or **▶▶** **▶**) to select the desired mode:

- **AUTO (NORM)** Provides optimised picture benefits of B.E.S.T. Picture System. When **B.E.S.T.** is **OFF**, **PICTURE CONTROL** switches automatically from **AUTO** to **NORM**.
- **EDIT** Minimizes picture degradation during editing (recording or playback).
- **SOFT** Reduces image coarseness when viewing overplayed tapes containing lots of noise.
- **SHARP** Clearer, sharper-edged picture when viewing images with lots of flat, same-coloured surfaces such as cartoons.

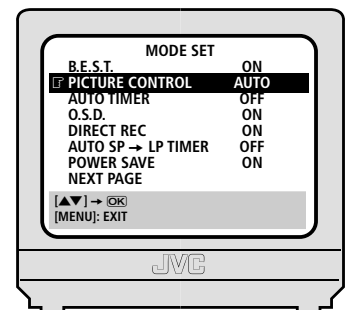

RETURN TO NORMAL SCREEN Press **MENU**.

The B.E.S.T. Picture System

ABOUT B.E.S.T.

Works in SP and LP modes

Does not work with Auto Satellite Prog Recording

Works before Timer Recording

B.E.S.T. data is lost when tape is ejected

Pressing the **●** button on VCR does not start Instant Timer Recording while B.E.S.T. is turned ON

The Biconditional Equalised Signal Tracking (B.E.S.T.) System checks the condition of the tape in use and compensates during recording and playback to give the best picture quality possible. The default setting is ON.



Turning B.E.S.T. ON or OFF

GET TO THE MODE SET SCREEN Press . Move the highlight bar to **MODE SET** using the and buttons and press (or).

SELECT B.E.S.T. MODE Move the highlight bar to **B.E.S.T.** using the and buttons and press (or) to set **B.E.S.T. ON** or **OFF**.

RETURN TO NORMAL SCREEN Press .

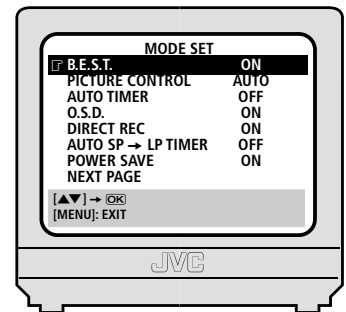

Recording and Playback Using B.E.S.T.

RECORDING Press and hold **●** and press on the Remote Control (or press **●** on the VCR). The VCR spends about 7 seconds assessing the condition of the tape and then begins recording.



During B.E.S.T.

→ pause of 7 seconds →



B.E.S.T. complete

PLAYBACK Press . The VCR adjusts the playback picture quality based on the condition of the tape in use. B.E.S.T. is active during Auto Tracking. **bESt** appears on the VCR's display panel.



Avoiding B.E.S.T. Time Delay

Since B.E.S.T. introduces a 7 second delay before recording starts, you may wish to compensate by first pressing **||** and **●** together (this puts the VCR into **RECORD PAUSE** mode during which time the VCR performs the B.E.S.T. tape assessment) and then pressing when you wish to start recording.

Sound Modes





NICAM Stereo and Bilingual Broadcasts

BEFORE YOU START

Set On Screen Display (O.S.D.) to ON

This VCR is equipped with a digital stereo sound decoder (**NICAM**) which makes the reception of stereo and bilingual broadcasts possible. When the VCR is tuned to a different preset, the type of broadcast will be displayed on the TV screen for a few seconds.

SELECT STEREO Press **AUDIO** until **HIFI L**  **R** appears on the TV screen.



SELECT BILINGUAL Press **AUDIO** until **HIFI L**  or **HIFI**  **R** appears on the TV screen (as required).

SELECT STANDARD To listen to standard monaural audio during a NICAM broadcast, press **AUDIO** until **NORM** appears on the TV screen.



Soundtrack Selection

This VCR is capable of recording three soundtracks and will play back the one that you select with the **AUDIO** button.

TRACK	USE
HI FI L  R	Hi-Fi stereo pre-recorded tapes
HI FI L 	Main audio of bilingual tapes
HI FI  R	Sub-audio of bilingual tapes
NORM	Audio-dubbed tapes
HI FI NORM	Audio-dubbed tapes



Notes



NORMAL SELECTION **HI FI L**  **R** should normally be selected. In this mode, Hi-Fi stereo tapes are played back in stereo and the normal audio track is played back automatically for tapes which only have normal audio.

RECORDING If the quality of reception is poor, the VCR will automatically record only the normal audio track which will give better quality sound under the circumstances.

Finding Specific Scenes



Skip Search







Press **30 SEC**  up to 4 times. Each press of the **30 SEC**  button will cause the VCR to go into fast-motion playback for a period of 30 seconds. Normal playback resumes automatically.







- To return to normal playback during a Skip Search, press .



Index Search



Each time you record a programme, this VCR puts an index marker at the point that you started recording. The VCR can fast wind to any one of nine index markers in either direction from the point that you stop the tape.

FINDING FIRST INDEX MARKER Press   or   once. The TV screen will display 1 or 1 and the VCR begins searching through the tape in the corresponding direction for the first index marker from its current position.

FINDING SUBSEQUENT INDEX MARKERS Press   or   the required number of times (e.g. five). The TV screen will display 5 or 5 and the VCR begins searching through the tape in the corresponding direction for the fifth index marker from its current position.



Instant ReView

Pressing the **REVIEW**  button causes the VCR to turn on, rewind to the beginning of the last timer-recorded programme and begin playback. The display panel tells you how many timer-recorded programmes are on the tape. If you have three, the REVIEW indicator and '3' blink on the display panel. To watch the first of these three programmes, press **REVIEW**  *three times*. You can move back up to nine programmes from your current position.

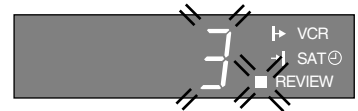

TIMER MODE Instant ReView will not work while the VCR is in Timer mode.

AUTO SATELLITE PROGRAMME RECORDING If **Auto Satellite Programme Recording** has been used to record the programmes, the number of recorded programmes will not be displayed on the display panel.

T-V Link Functions

When you connect the VCR and your TV via both the RF cable and the fully-wired 21-pin SCART cable (📺 pg. 9), the following functions are available. You can use these functions only with a TV offering T-V Link, etc.* For details, refer to the instruction manual for your TV.

* Compatible with TVs offering T-V Link, EasyLink, Megallogic, SMARTLINK, Q-Link, DATA LOGIC or NexTView Link via fully-wired 21-pin SCART cable. The degree of compatibility and available functions may differ by system.



NexTView Link

You can download the EPG (Electronic Programme Guide) information from your TV for timer-programming on the VCR.

For details, refer to the instruction manual for your TV.



TV Auto Power On

You can turn on the TV and set it to video mode automatically whenever you play a tape.

For details, refer to the instruction manual for your TV.



VCR Auto Standby

You can use your TV's Remote Control to turn off the VCR.

For details, refer to the instruction manual for your TV.



Direct Rec

You can start recording the programme that you are watching on your TV with simple operation. Press and hold **●** and press **▶** on the Remote Control, or press **●** on the VCR. Follow the procedure below to use this function.

GET TO THE MODE SET SCREEN Press . Move the highlight bar to **MODE SET** using the and buttons and press (or).

SELECT DIRECT REC MODE Move the highlight bar to **DIRECT REC** using the and buttons. Press (or) to select **ON** or **OFF**.

RETURN TO NORMAL SCREEN Press .

NOTES

- If **DIRECT REC** is set to **OFF**, the **●** button functions as described in **Recording** (pg. 18).
- During the Direct Rec, '—' appears on the display panel.
- Direct Rec is not possible with a scrambled broadcast. To record a scrambled broadcast, set **DIRECT REC** to **OFF** and follow the procedure described in **Recording** on page 18.

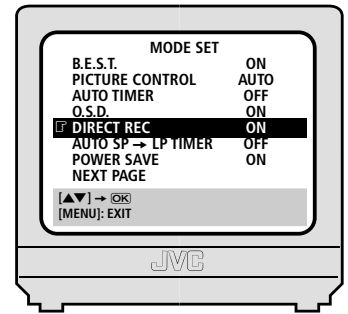

Satellite Receiver Control Settings

The following procedure is required if you receive satellite channels through a satellite receiver. Around 20 seconds before the VIDEO Plus+ timer recording or Manual timer recording starts, the VCR sets its input mode to L-2 and automatically switches the satellite receiver's channels using the provided Satellite Controller.

1

Installing Satellite Controller

SITUATE SATELLITE CONTROLLER Place the Satellite Controller so that the path between its transmitter and the satellite receiver's remote sensor is unobstructed.

ATTACH SATELLITE CONTROLLER Fix securely using the adhesive strip attached on the back of the Satellite Controller.

CONNECT UP Be sure to connect the recorder's **AV2 (L-2) IN/DECODER** connector to the satellite receiver's 21-pin SCART connector.

NOTE When connecting your satellite receiver, refer to its instruction manual.

CONNECT SATELLITE CONTROLLER TO VCR Connect the Satellite Controller to the **SAT CONTROL** connector on the rear panel.

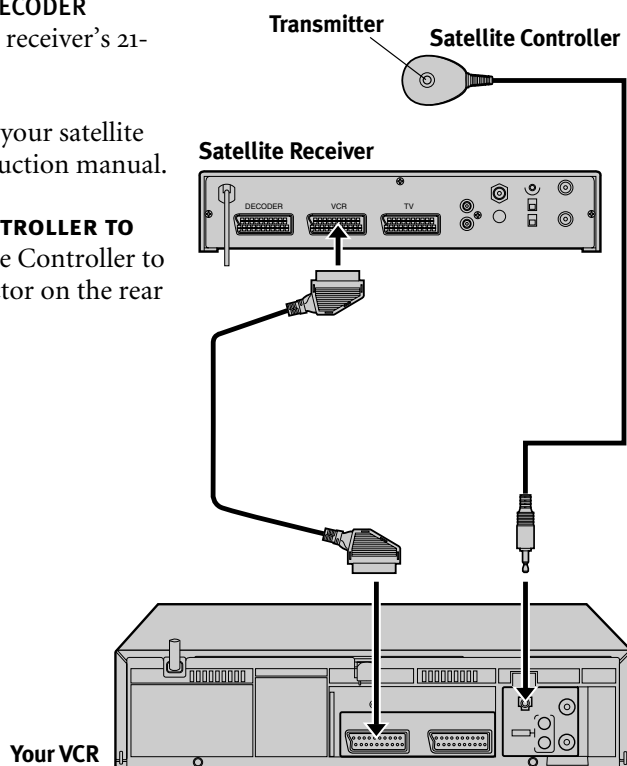
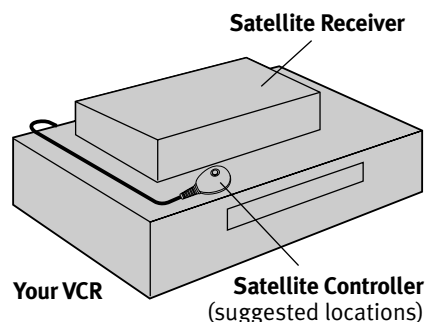

2

Setting satellite receiver's brand

After installation, set the satellite receiver's brand correctly and perform test; otherwise, the Satellite Controller cannot work correctly.

TURN ON SATELLITE RECEIVER Turn on the satellite receiver's power.

GET TO THE MODE SET SCREEN Press . Move the highlight bar to **INITIAL SET** using the and buttons and press (or).

GET TO THE SAT CONTROL SET SCREEN Move the highlight bar to **SAT CONTROL SET** using the and buttons. Press (or).

ENTER SATELLITE RECEIVER'S BRAND Press the appropriate number keys to enter the brand code from the list below, then press .

- If the brand code you entered is invalid, the code field is reset. Enter the correct brand code again.
- If the VCR is in playback or recording mode, you cannot set the brand code.

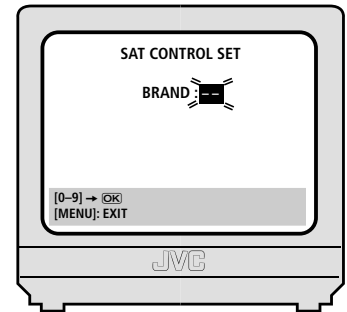

SATELLITE RECEIVER BRAND	CODE
JVC	73
AMSTRAD	60, 61, 62, 63, 92
CANAL SATELLITE	81
CANAL +	81
D-BOX	85
ECHOSTAR	78, 79, 80
ECHOSTAR (VIA DIGITAL)	82
FINLUX	68
FORCE	89
GALAXIS	88
GRUNDIG	64, 65
HIRSCHMANN	64, 78, 99
ITT NOKIA	68
JERROLD	75
KATHREIN	70, 71, 96
LUXOR	68

SATELLITE RECEIVER BRAND	CODE
MASCOM	93
MASPRO	70
NOKIA	87, 94
PACE	65, 67, 74, 86, 92
PANASONIC	74
PHILIPS	66, 84
RFT	69
SABA	97
SAGEM	83, 90
SALORA	68
SIEMENS	64
SKYMASTER	69, 98
THOMSON	97
TPS	83
TRIAX	91
WISI	64

SELECT SATELLITE RECEIVER'S PRESET POSITION FOR TESTING Press the appropriate number keys to enter one of the channel positions on the satellite receiver, then press .

- You can select the channel position between 1 to 999.
- After pressing , the VCR enters the Test mode.

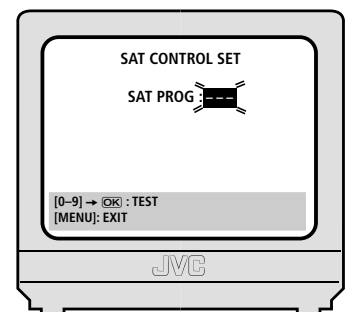





3 Check Result of Test

If the satellite receiver's channel number has been changed to the same channel as you set ...

Press the  and  buttons to move the highlight bar to **CHANGED TO ...**, then press  (or  ) to finish the Sat Control Set mode.

If the satellite receiver's channel number has not been changed correctly ...

Press the  and  buttons to move the highlight bar to **NOT CHANGED**, then press  (or  ). Then perform the procedure again from entering the satellite receiver's brand code.

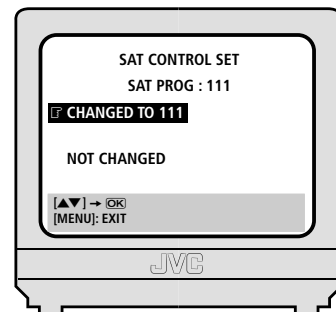

Notes

- The Satellite Controller may not work with all types of satellite receiver.
- For some satellite receivers, you need to set its channel input mode to 2-digit.
- If your satellite receiver has more than two channel modes, be sure to set to **All Channel Mode**. For details, refer to the instruction manual of the satellite receiver.
- When selecting the satellite receiver's preset position for testing, signals from the Remote Control may interfere with signals transmitted from the Satellite Controller. In this case, move the Remote Control as close to the recorder's infrared beam receiving window as possible.

Auto Satellite Programme Recording







Auto Record from Satellite Receiver

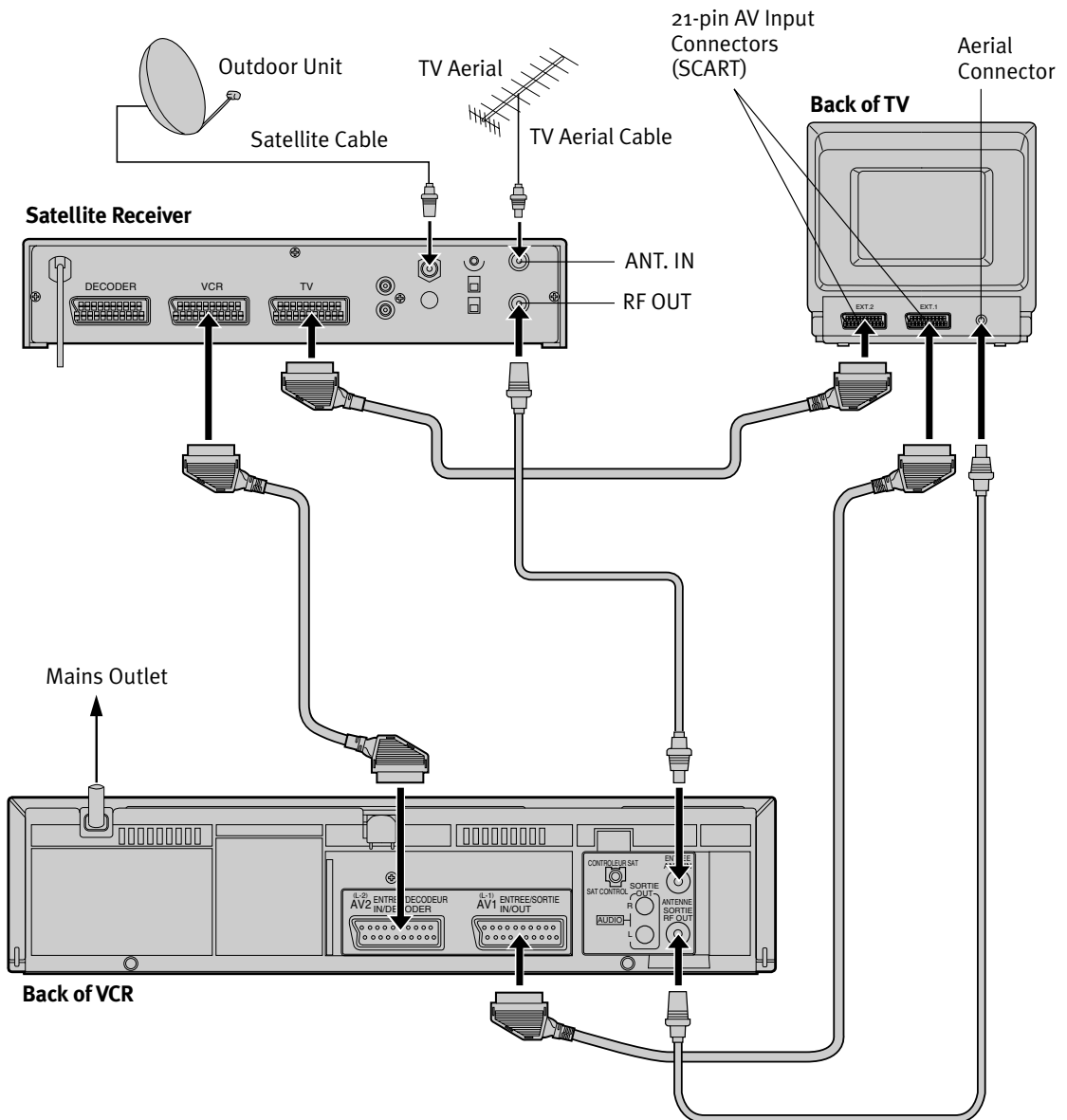

This facility allows a programme timer-recorded using the satellite receiver to be recorded on the VCR.

CONNECT UP Connect your satellite receiver, TV and VCR (see diagram below).





PROGRAMME SATELLITE RECEIVER Enter the details of the programme into your satellite receiver (*see receiver manual*) and put a tape in the VCR.

GET TO THE MODE SET SCREEN Press . Move the highlight bar to **MODE SET** using the  and  buttons and press  (or ).

SELECT L-2 SELECT MODE Move the highlight bar to **L-2 SELECT** using the  and  buttons. Press  (or ) to select **L-2** or **SAT**. Then press .

SET TAPE SPEED Press  on the Remote Control to set the tape speed to either **SP** or **LP**.



ENGAGE VCR IN AUTO MODE Press and hold **SAT**  on the VCR for about 2 seconds. The **SAT**  indicator on the VCR display panel lights up and the VCR turns off automatically. Any signal detected at the **AV2 (L-2) IN/DECODER** connector will automatically start the VCR recording; when the signal stops, so will the VCR.



Notes

CONNECTORS Auto Satellite Prog Recording is only possible using the **AV2 (L-2) IN/DECODER** connector.

TIMER MODE You cannot put the VCR into **TIMER MODE** when using Auto Satellite Prog Recording Mode.

REVIEW  The number of programmes recorded will not be displayed on the VCR display panel when the **REVIEW**  button is pressed.

TIMER RECORDING Auto Satellite Prog Recording is not possible if your satellite receiver does not have a timer.

INDICATOR The **SAT**  indicator light flashes when Auto Satellite Prog Recording is in progress.

DISENGAGE To disengage the VCR during Auto Satellite Prog Recording, press the  button. The VCR will stop recording and turns off.

TAPE SPEED When recording two or more programmes consecutively, you cannot set a different tape speed for each programme. The first speed selected will apply to all programmes in that recording session.

B.E.S.T. The **B.E.S.T.** system will not work during Auto Satellite Prog Recording.

JUST CLOCK **Just Clock** does not work when in Auto Satellite Prog Recording mode.

INCOMING SIGNAL The VCR will only react to the start of an incoming signal at the **AV2 (L-2) IN/DECODER** connector. If you try to engage Auto Satellite Prog Recording Mode whilst the satellite receiver is powered on, the **SAT**  indicator light will flash but the VCR will not record. You must power the satellite receiver off then on again to begin recording in these circumstances.

CABLE INPUT You can record in the same way from a cable system as long as you connect the cable system has a timer on/off function and is connected to the **AV2 (L-2) IN/DECODER**.

INCOMPATIBILITIES Some satellite receivers output signals even when turned off. These receivers cannot be used with this VCR in this way.

Editing



L-2 SELECT Setting

Set **L-2 SELECT** to the appropriate mode depending on the type of unit connected to the rear panel **AV2 (L-2) IN/DECODER** connector of this VCR.

GET TO THE MODE SET SCREEN Press . Move the highlight bar to **MODE SET** using the and buttons and press (or).

SELECT L-2 SELECT MODE Move the highlight bar to **L-2 SELECT** using the and buttons. Press (or) to select the desired mode:

- **A/V** To use this VCR as the recording deck with the player connected to the **AV2 (L-2) IN/DECODER** connector, or to use the satellite receiver connected to the **AV2 (L-2) IN/DECODER** connector.
- **DECODER** To use a decoder connected to the **AV2 (L-2) IN/DECODER** connector.
- **SAT** To view a satellite programme with the TV set while the VCR is turned off.

RETURN TO NORMAL SCREEN Press .



Notes

- When **L-2 SELECT** is set to **SAT**, it is possible to view a satellite broadcast with the TV set to its AV mode even if the VCR is turned off. When the VCR is in the stop mode or recording, press **TV/VCR** on the Remote Control to turn off the VCR indicator on the display panel.
If you turn on the VCR when the satellite receiver's power is off, nothing appears on the TV screen. In this case, turn off the satellite receiver, or set the TV to its TV mode, or press **TV/VCR** on the Remote Control to set the VCR to the video mode.
- When **L-2 SELECT** is set to **SAT**, **SAT** appears on the TV screen or **SAt** on the display panel instead of **L-2**.
- If you have a satellite receiver or a decoder connected to the **AV2 (L-2) IN/DECODER** connector, be sure to set **L-2 SELECT** back to appropriate mode after editing.
- If you're not connecting a satellite receiver or a decoder to the **AV2 (L-2) IN/DECODER** connector, leave **L-2 SELECT** set to **A/V**.
- The default setting is **A/V**; if the VCR's memory backup has expired due to a power cut or because the AC was removed from the VCR, **A/V** will be automatically selected when the power is restored to the VCR. If you are using a satellite receiver or a decoder, be sure to set **L-2 SELECT** back to appropriate mode.



Editing Using Another VCR

CONNECT UP Connect the two VCRs together using a 21-pin SCART cable. If this VCR is to be the player, connect its **AV1 (L-1) IN/OUT** connector to the recording VCR. If this VCR is to be the recorder, you can use either the **AV1 (L-1) IN/OUT** or the **AV2 (L-2) IN/DECODER** connector to connect to the player VCR.

SET RECORDER INPUT MODE The recording VCR mode must be set to **AUX**. If this VCR is the recorder, press **AUX** and /or **PR** to select **L-1** (if you've used the **AV1 (L-1) IN/OUT** connector) or **L-2** (if you've used the **AV2 (L-2) IN/DECODER** connector) then set **O.S.D.** to **OFF**. (☞ pg. 44)

- When using the **AV2 (L-2) IN/DECODER** connector, set **L-2 SELECT** to the appropriate mode. (☞ pg. 41)

SET EDIT MODE See Picture Control on page 30.

START SOURCE VCR Engage its **PLAY** mode.

START RECORDING VCR Engage its **RECORD** mode.

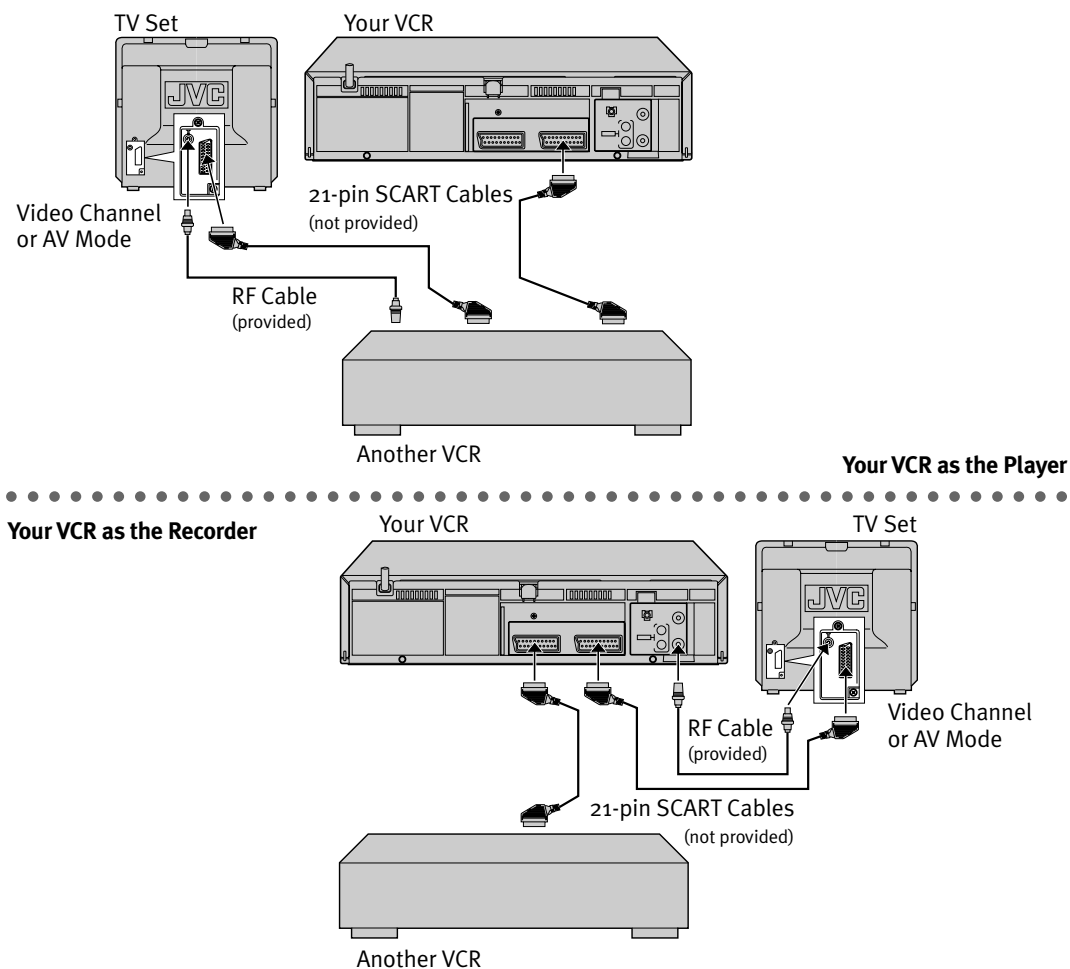



Editing from a Camcorder

CONNECT UP Connect the Camcorder's **AUDIO/VIDEO OUT** connector to the VCR's rear panel **AV1 (L-1) IN/OUT** or the **AV2 (L-2) IN/DECODER** connector, via an optional cable adapter.

SET INPUT MODE Press **AUX** or **PR** so that **L-1** (for **AV1 (L-1) IN/OUT** connector) or **L-2** (for **AV2 (L-2) IN/DECODER** connector) appears in the place of a preset position number.

SET EDIT MODE See *Picture Control on page 30*.

START CAMCORDER Engage the camcorder's **PLAY** mode.

START RECORDER Press ●.

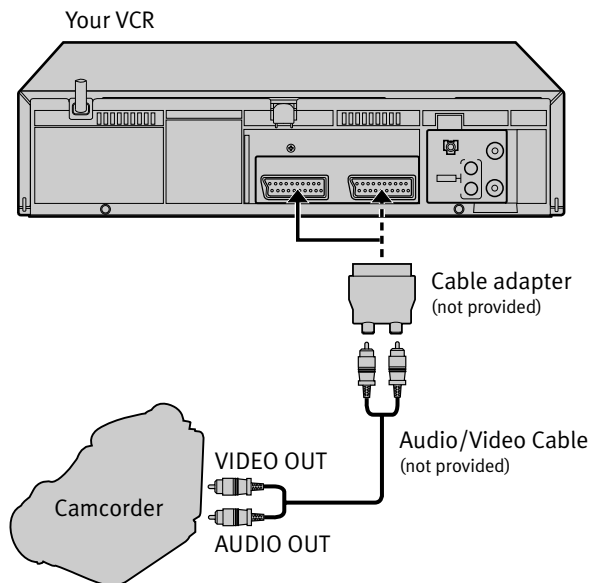

Other Functions



On-Screen Display (O.S.D.)

This function allows you to turn the on-screen information **ON** or **OFF**.

GET TO THE MODE SET SCREEN Press , move the highlight bar to **MODE SET** using the and buttons and press (or).

ENABLE/DISABLE OSD The default setting for **OSD** is **ON**. Move the highlight bar to **OSD** using the and buttons and press (or) to toggle between **ON** and **OFF**.

RETURN TO NORMAL SCREEN Press .

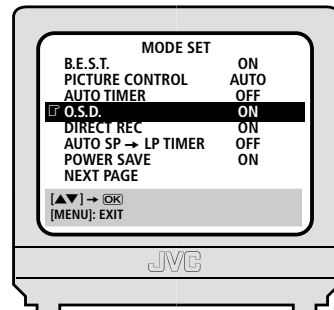



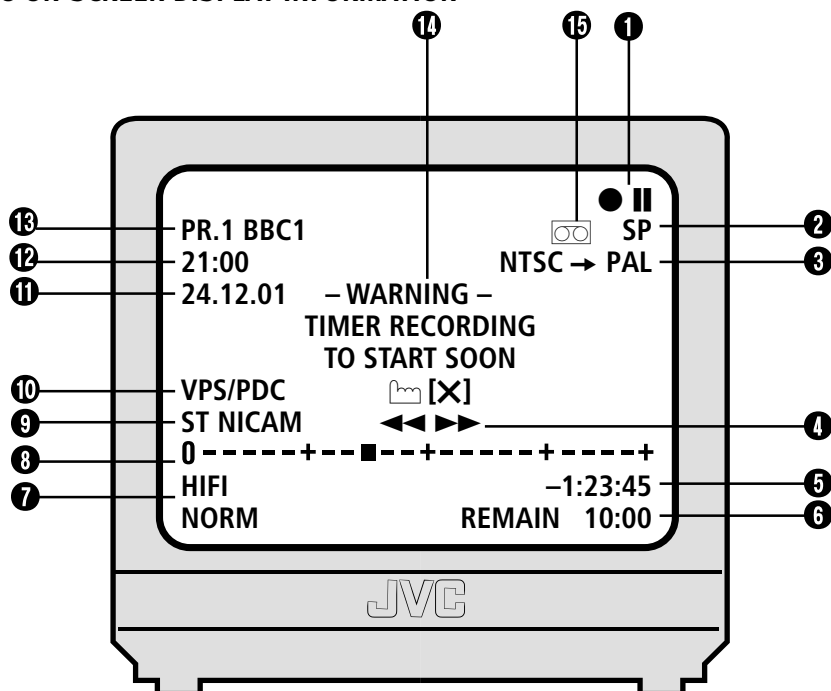

GUIDE TO ON-SCREEN DISPLAY INFORMATION







- | | | |
|---|---------------------------|---|
| 1 Operation mode indicators | 6 Tape remaining time | 13 Preset position number and station name/
Auxiliary input mode indicator (L-1, L-2 or SAT) |
| 2 Tape speed SP/LP/EP (EP is for NTSC only) | 7 Audio mode | 14 Timer warning |
| 3 NTSC playback display | 8 Tape position indicator | 15 'Cassette Loaded' indicator |
| 4 Tape direction | 9 NICAM display | |
| 5 Counter display | 10 VPS/PDC indicator | |
| | 11 Day/month/year | |
| | 12 Current time | |

Power Save Mode

You can reduce the power consumption while the VCR is turned off.

GET TO THE MODE SET SCREEN Press . Move the highlight bar to **MODE SET** using the  and  buttons and press  (or ).



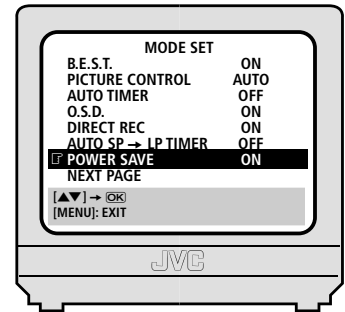

SELECT POWER SAVE MODE Move the highlight bar to **POWER SAVE** using the  and  buttons. Press  (or ) to select ON or OFF.





RETURN TO NORMAL SCREEN Press .



Auto SP → LP Timer

When timer recording in **SP** mode, if the VCR calculates that there isn't enough tape to record the complete programme, it will automatically switch from **SP** to **LP** mode.

GET TO THE MODE SET SCREEN Press . Move the highlight bar to **MODE SET** using the  and  buttons and press  (or ).



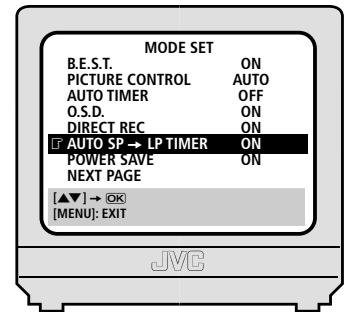

ENABLE/DISABLE AUTO SP→LP TIMER Select **AUTO SP→LP TIMER** using the  and  buttons and press  (or ) to toggle between ON and OFF.





RETURN TO NORMAL SCREEN Press .



Auto Timer

When the **AUTO TIMER** is set to **ON**, the timer is automatically engaged when the VCR power is turned off and automatically disengaged when the VCR is powered back on.

GET TO THE MODE SET SCREEN Press . Move the highlight bar to **MODE SET** using the  and  buttons and press  (or ).

ENABLE/DISABLE AUTO TIMER Select **AUTO TIMER** using the  and  buttons and press  (or ) to toggle between ON and OFF.

RETURN TO NORMAL SCREEN Press .

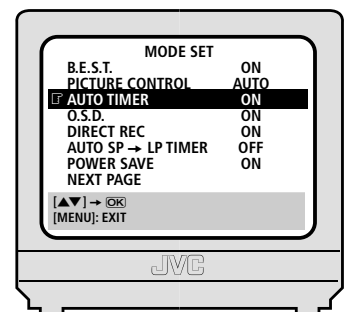



Repeat Playback

START REPEAT PLAYBACK Press ►, then press and hold ► again for over 5 seconds, then release. The Play indicator (▷) will flash on the display panel and the VCR will automatically playback and rewind the tape 100 times and then stop.

STOP PLAYBACK Pressing ■, ►, ◀◀◀ or ▶▶▶ stops repeat playback.



Next Function Memory

PLAY To playback immediately after rewinding, press ◀◀◀ and then ► within 2 seconds.

POWER OFF To power off the VCR immediately after rewinding, press ◀◀◀ and then ⏻ within 2 seconds.

TIMER STANDBY To put the VCR in timer standby mode immediately after rewinding, press ◀◀◀ and then ⏸ within 2 seconds.

Connection to a Stereo System

It is possible to connect your VCR to a suitably equipped stereo system and listen to the soundtrack through the stereo system.

CONNECT UP Connect the **AUDIO OUT L** and **R** connectors on the VCR to the **AUX IN** or **TAPE MONITOR** connectors on your stereo. See diagram below.

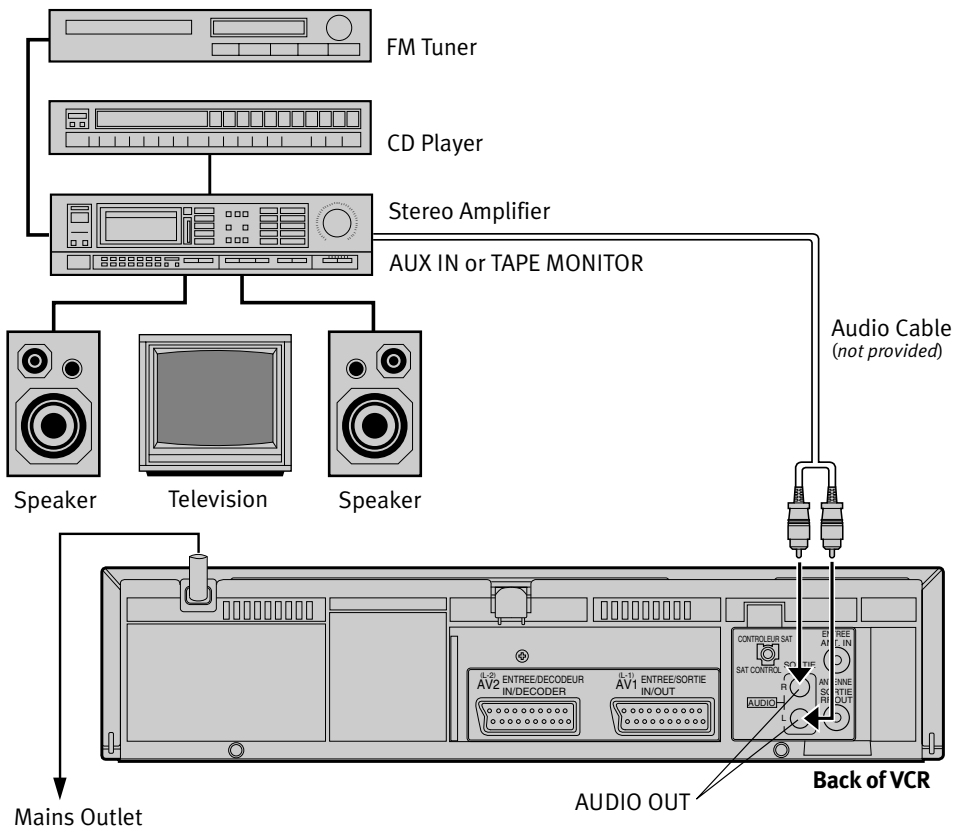

NOTES ON STEREO CONNECTIONS

SPEAKER CONNECTIONS Make sure that you connect the L and R speakers in the right order.

NICAM TV If you can receive NICAM TV broadcasts in your area, this VCR can record them independently of the TV set and play them back through the stereo.

VOLUME When listening to sound through the connected stereo, turn the TV's volume down to zero.

DYNAMIC RANGE This VCR has a Hi-Fi audio dynamic range of 80dB. Check that your stereo is capable of handling this level of input. If it cannot, you risk speaker damage.

Video Channel Set

BEFORE YOU START

The power cord must be plugged in and connected to the VCR

The VCR must be turned off and no cassette inserted

The Remote Control must have batteries inserted

The TV set must be turned on

The VCR can send picture signals to the TV set in one of two ways; RF (ordinary cable included with this VCR) and AV (via a 21-pin SCART cable available from TV and Hi-Fi dealers). Depending upon which method you use, the VCR must have the correct method set up in order to work. The Auto Setup procedure normally takes care of this but if for any reason this fails to happen, the instructions below describe how to set the Video Channel manually.

1 Access Video Channel Mode



Press and hold the  button on the VCR until the display panel shows the following information:

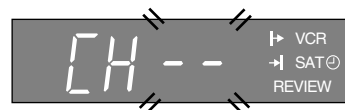

2 Set Video Channel

FOR AV CONNECTION Press  until the display panel shows:
The Video Channel is now set to OFF.
Go to **Step 3**.



FOR RF CONNECTION Press  or  to set the VCR to a vacant channel number between 22 and 69 which is not occupied by any station in your area (*refer to station list on page 53*). In the example, we have presumed that channel 36 is vacant and have set the VCR to 36:

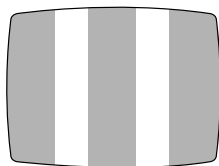

Now tune the TV set to channel 36 (*refer to TV manual if necessary*); you should see two vertical white bars appear on the TV screen. If the bars do not appear or are not clear, choose another vacant channel and try again. If you cannot obtain the vertical white bars on any channel between 22 and 69, consult your local JVC dealer.

3 Exit Video Channel Set Mode

Press .

To view pictures from your VCR you must now set your TV to either the Video Channel or to AV mode, depending upon your choice above.

Tuner Set

The VCR needs to find, identify and memorise all available stations in your area in order to record programmes correctly. Once done, pressing the or buttons enables you to jump to the available channels without going via any vacant channels. This channel search can be done either automatically or manually. You should only need to perform either of the following procedures if Auto Setup or Preset Download has failed to identify and record available channels or you have moved to a new area.



Auto Channel Setup

GET TO THE MAIN MENU Press .

PERFORM AUTO CHANNEL SET Move the highlight bar to **AUTO CH SET** using the and buttons and press (or or) *twice*.

The **AUTO SET** screen will appear on the TV and remains there for about 4–12 minutes while the VCR searches for receivable stations. During Auto Channel Set the mark on the screen moves from left to right.

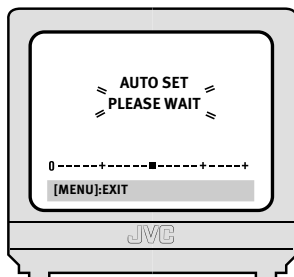
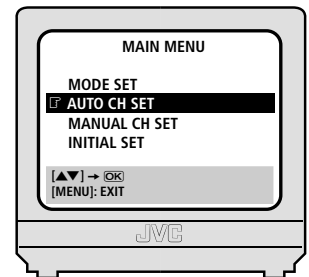

The caption **SCAN COMPLETED** appears at the end of the process for about 5 seconds.

CONFIRMATION SCREEN Once Auto Channel Set has completed its search, the confirmation screen will appear showing the details (PR = Preset Number, CH = Channel Number and ID = Station

Name) of the TV stations that the process has found. The first station will have a highlight bar over it and will be blinking. This screen and the programme currently being broadcast on the selected station will alternate at 8 second intervals. To view the next channel, press the and buttons to move the highlight bar to the required channel.

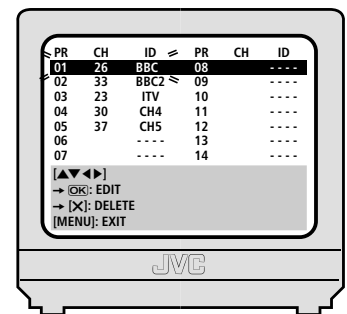

RETURN TO NORMAL SCREEN Press .

NOTES ON CHANNEL RECEPTION

INCORRECT STATION ID In certain reception conditions, station names may not be stored correctly by the VCR and Auto Guide Program Number Set may not work properly. If the Guide Program Numbers are not set, entering a PlusCode, may result in an incorrect channel being recorded.

POOR RECEPTION The VCR memorises all stations found regardless of their quality. If a station's quality is poor, you can delete that station from the memory (*see page 51*).



Manual Channel Setup

GET TO THE CONFIRMATION SCREEN Press . Move the highlight bar to **MANUAL CH SET** using the and buttons and press (or).

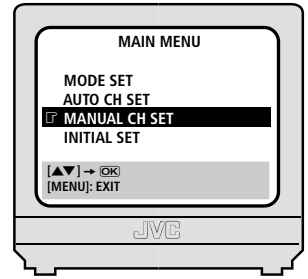

SELECT POSITION Use the

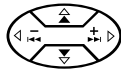

button on the Remote Control to move the highlight bar to a vacant position then press . In this example, we have chosen position 6.

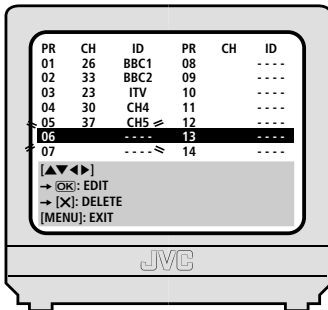

SELECT BAND When the **MANUAL CH SET** screen appears, press the and buttons to change the band between CH (regular) and CC (cable).

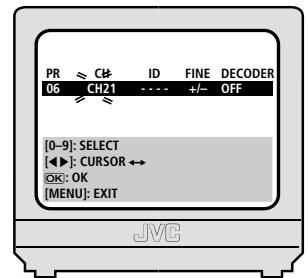

INPUT CHANNEL NUMBER Press the button and you will see the channel number space flashing. Use the number keys to enter the Channel Number that you want to store.

INPUT CHANNEL ID Press the button to move to the Channel ID space and use the and buttons to select the required ID from the stored list.

FINE TUNING Press the button to move to the Fine Tuning '+/-' and use the and buttons to fine-tune the channel. A '+' or a '-' symbol will appear during this process.

SELECT DECODER SETTING When receiving a scrambled broadcast with a decoder connected to the AV2 (L-2) IN/DECODER connector, set L-2 SELECT to **DECODER** (see pg. 41) and set **DECODER** setting to **ON**. When L-2 SELECT is set to **A/V** or **SAT**, the **DECODER** setting cannot be changed.

SAVE NEW CHANNEL DETAILS Press to save the details you have just entered. The Confirmation Screen will appear again. Repeat the above procedure from **Select Position** onwards as many times as required.

CLOSE CONFIRMATION SCREEN Press .



Change Station Name

GET TO THE CONFIRMATION SCREEN Press . Move the highlight bar to **MANUAL CH SET** using the and buttons and press (or).

SELECT POSITION Use the button on the Remote Control to move the highlight bar to the preset position you want then press twice.

SELECT CHARACTER Press until the first letter of the station name begins blinking.

ENTER NEW CHARACTER Press the and buttons to cycle through the characters (A-Z, 0-9, -, *, +, _ (space)) and stop when the desired character is indicated, then press to enter. Enter the remaining characters the same way (maximum of 4). After entering all characters, press .

- The Confirmation screen appears.
- If you make a mistake, press until the incorrect character begins blinking. Then enter the correct character by pressing the and buttons.

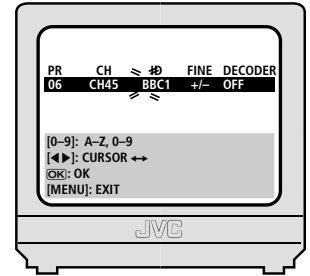

CLOSE CONFIRMATION SCREEN Press .



Delete a Channel

GET TO THE CONFIRMATION SCREEN Press . Move the highlight bar to **MANUAL CH SET** using the and buttons and press (or .

SELECT CHANNEL Use the button on the Remote Control to move the highlight bar to the channel that you wish to delete.

DELETE CHANNEL Press **X**.

RETURN TO NORMAL SCREEN Press .

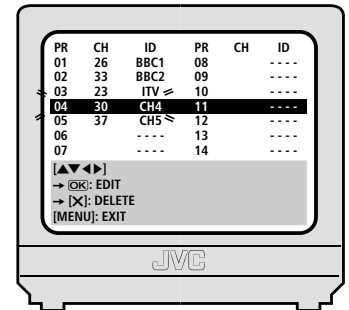



Change Station Preset Position

GET TO THE CONFIRMATION SCREEN Press . Move the highlight bar to **MANUAL CH SET** using the and buttons and press (or).

SELECT ITEM Use the button on the Remote Control until the item you want to move begins blinking then press . The station name (ID) and its channel (CH) number begin blinking.

SELECT NEW POSITION Use the button to move the station to the new preset position, then press .

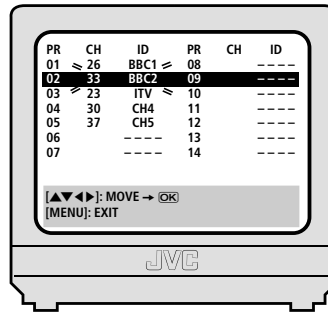
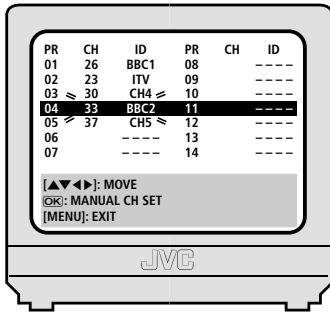

Example: If you moved the station in position 4 to position 2, the stations originally in positions 2 and 3 each move down one space.

CLOSE CONFIRMATION SCREEN Press .



Fine-Tuning Stored Channels

GET TO THE CONFIRMATION SCREEN Press . Move the highlight bar to **MANUAL CH SET** using the and buttons and press (or).

SELECT ITEM Use the button on the Remote Control to move the highlight bar to the channel that you wish to fine-tune then press twice.

FINE TUNING Press the button to move to the Fine Tuning '+/-' and use the and buttons to fine-tune the channel. A '+' or '-' symbol will appear during this process.

SAVE NEW DETAILS Press to save the details you have just entered. The Confirmation Screen will appear again.

CLOSE CONFIRMATION SCREEN Press .



TV Station ID Guide

STATION NAME	ID
Anglia TV	ANGL
ARD	ARD
ARTE	ARTE
BBC Group	BBC
BBC1	BBC1
BBC2	BBC2
Berlin 1	BLN1
Berlin 2	BLN2
Border TV	BORD
Bayern1	BR1
Bayern3	BR3
BRT1	BRT1
BRT2	BRT2
Children Ch	CHLD
Canal +	CH+
CNN	CNN
Channel TV	CHNL
Central TV	CNTR
Channel 4	CH 4
Channel 5	CH 5
DRS	DRS
DR TV	DRTV
DSF	DSF
Euronews	EURN
Euronews	EURO
Eurosports	EURS
France1	FR1
France2	FR2
France3	FR3
Granada TV	GRNA

STATION NAME	ID
Grampian TV	GRMP
Hessen1	HR1
Hessen3	HR3
HRT	HRT
HTV	HTV
ITV Network	ITV
Kabelkanal	KABL
London	LNDN
MDR	MDR
MTV	MTV
Nord3	N3
NDR1	NDR1
NDR3	NDR3
NED1	NED1
NED2	NED2
NED3	NED3
Network 2	NET2
NRK	NRK
N-TV	N-TV
Offener Kanal	OKAN
ORF1	ORF1
ORF2	ORF2
ORF3	ORF3
OWL 3	OWL3
Premiere	PRM1
PR07	PR07
RAI1	RAI1
RAI2	RAI2
RAI3	RAI3
RB1	RB1

STATION NAME	ID
RB3	RB3
Rikisutvarpid-S	RKPS
RTBF 1	RTB1
RTBF 2	RTB2
RTE 1	RTE1
RTL	RTL
RTL 2	RTL2
RTP	RTP
SAT	SAT
SAT 1	SAT1
Scottish TV	SCOT
SC4	SC4
SDR	SDR
SDR1	SDR1
SFB1	SFB1
SFB3	SFB3
SKY	SKY
Sky One	SKY1
Sky Net	SKYN
Sport	SPRT
SR 1	SR1
Super RTL	SRTL
STV Test	STVT
STV 1	STV1
STV 2	STV2
Suedwest3	SWR
SWF 1	SWF1
Schweiz4	SWZ4
TYNE TEES	TEES
Text	TEXT

STATION NAME	ID
TF1	TF1
TNT int	TNT
TRT int	TRT
TSI	TSI
TSR	TSR
TSW	TSW
TVE	TVE
TV Polonia	TVPA
TVP 1	TVP1
TVP 2	TVP2
TVS	TVS
TV2	TV2
TV5	TV5
Tele Zurich	TZUR
Ulster TV	ULST
Veronica	VERN
VIVA	VIVA
VIVA2	VIV2
VOX	VOX
VTM	VTM
VT4	VT4
West1	WDR1
West3	WDR3
YLE 1	YLE1
YLE 2	YLE2
Yorkshire TV	YORK
ZDF	ZDF
Zurich 1	ZUR1
3SAT	3SAT



TV Station Channel Number Guide

Region	Transmitter	BBC1	BBC2	ITV	CH4	CH5
London & South-East	Bluebell Hill	40	46	43	65	—
	Crystal Palace	26	33	23	30	37
	Dover	50	56	66	53	—
	Heathfield	49	52	64	67	—
	Oxford	57	63	60	53	49
South-West	Beacon Hill	57	63	60	53	—
	Caradon Hill	22	28	25	32	—
	Huntshaw Cross	55	62	59	65	67
	Redruth	51	44	41	47	37
	Stockland Hill	33	26	23	29	—
	Channel Islands Fremont Point	51	44	41	47	—
South	Hannington	39	45	42	66	35
	Midhurst	61	55	58	68	—
	Rowridge	31	24	27	21	—
West						
East	Mendip	58	64	61	54	37
	Sandy Heath	31	27	24	21	39
Midlands	Sudbury	51	44	41	47	35
	Tacolneston	62	55	59	65	52
	Ridge Hill	22	28	25	32	35
	Sutton Coldfield	46	40	43	50	37
North	The Wrekin	26	33	23	29	35
	Waltham	58	64	61	54	35
	Belmont	22	28	25	32	56
	Emley Moor	44	51	47	41	37
North-West	Caldbeck	30	34	28	32	56
	Winter Hill	55	62	59	65	48
North-East	Bilsdale West Moor	33	26	29	23	35
	Chatton	39	45	49	42	—
	Pontop Pike	58	64	61	54	68
Scotland	Angus	57	63	60	53	—
	Black Hill	40	46	43	50	37
	Sandale	22	—	—	—	—
	Caldbeck	—	34	28	32	56
	Creigkelly	31	27	24	21	48
	Darvel	33	26	23	29	35
	Durris	22	28	25	32	67
	Eitshal	33	26	23	29	—
	Keelylang Hill	40	46	43	50	—
	Knock More	33	26	23	29	—
	Rosemarkie	39	45	49	42	67
	Rumster Forest	31	27	24	21	—
	Selkirk	55	62	59	65	52
	Wales	Blaenplwyf	31	27	24	21
Carmel		57	63	60	53	—
Llanddona		57	63	60	53	—
Moel-y-Parc		52	45	49	42	—
Presely		46	40	43	50	37
Wenvoe		44	51	41	47	—
Northern Ireland	Brougher Mountain	22	28	25	32	—
	Divis	31	27	24	21	37
	Limavady	55	62	59	65	—

Clock Set

You should only need to perform this function if:

- Auto Clock Set was not performed correctly by Auto Setup, Preset Download or Auto Channel Set
- The VCR's memory backup has expired
- You want to change the Just Clock setting



Setting the Clock

GET TO THE INITIAL SET SCREEN Press . Move the highlight bar to **INITIAL SET** using the and buttons and press (or).

GET TO THE CLOCK SET SCREEN Move the highlight bar to **CLOCK SET** using the and buttons and press (or).

SET TIME AND DATE When the **CLOCK SET** screen appears, the time will be blinking. Use the and buttons to set the correct time (*pressing and holding will advance the time in 30 minute increments*) and then press (or). The date will blink. Use the and buttons to set the correct date (*pressing and holding will advance the date in 15 day increments*) and then press (or). Set the correct year in the same way and press .



SET JUST CLOCK Set as desired using the and buttons then press (or .

SET PRESET FOR CLOCK DATA SOURCE If you have set **JUST CLOCK** to **ON**, you will need to specify a preset (station) for **JUST CLOCK** to take its source data from. Use the and buttons to select the preset and press (or .

START CLOCK OPERATION Press .



Notes on Just Clock

Some TV stations transmit a time signal with their broadcasts. This VCR has the ability to use this signal to update its internal clock (*including the adjustment for British Summer Time*). It will do this every hour except for 23:00, 00:00, 01:00 and 02:00. By setting **Just Clock** to **ON**, you are enabling the VCR to do this.

Just Clock is not effective in the following circumstances:

- when the VCR is powered on
- when the VCR is in Timer or Auto Satellite Programme Recording modes
- when a difference of more than 3 minutes between the internal clock and the time signal exists.
- when reception conditions are poor.
- when L-2 **SELECT** is set to **SAT**. (see pg. 41)

Guide Program Numbers

Guide Program Numbers are used by the VIDEO Plus+ system to identify the correct preset to record. You should only need to perform this function if:

- using a PlusCode does not identify a preset number automatically
- you add a channel after Auto Setup or Preset Download has been performed
- you wish to use the VIDEO Plus+ system to record a satellite programme



Manually Setting Guide Program Numbers

GET TO THE GUIDE PROG SET SCREEN Press . Move the highlight bar to **INITIAL SET** using the and buttons and press (or). Move the highlight bar to **GUIDE PROG SET** using the and buttons and press (or).

ENTER GUIDE PROG NUMBER Use the and buttons to enter the correct Guide Program number for the TV station shown then press (or).

ENTER RECEIVING PRESET NUMBER Press **AUX** (number key '0') to select **TV PROG** or **SAT**. Use the and buttons to enter the receiving preset number that the VCR or satellite receiver uses to receive the TV station then press (or .

SATELLITE RECEIVER USERS To timer-record a satellite programme with the VIDEO Plus+ system, you need to install the provided Satellite Controller and perform the procedure described in **Satellite Receiver Control Setting** (pg. 36).

RETURN TO NORMAL SCREEN Press .

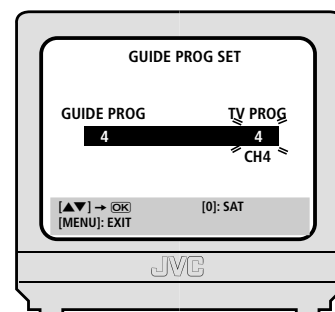

Question and Answers

PLAYBACK

Q: What happens if the end of the tape is reached during playback or search?

A: *The tape is automatically rewound to the beginning.*

Q: Can the VCR indefinitely remain in the still mode?

A: *No. It stops automatically after 5 minutes to protect the heads.*

Q: During search, slow, still and frame-by-frame playback, I can't hear any audio.

What's the problem?

A: *This is normal.*

Q: When returning from variable-speed search to normal playback, the picture is disturbed. Should I be concerned about this?

A: *No, it is normal.*

Q: Noise bars appear during variable-speed search. What's the problem?

A: *This is normal.*

Q: Sometimes, during Index Search, the VCR can't find the programme I want to see. Why not?

A: *There may be index codes too close together.*

RECORDING

Q: When I pause and then resume a recording, the end of the recording before the pause is overlapped by the beginning of the continuation of recording. Why does this happen?

A: *This is normal. It reduces distortion at the pause and resume points.*

Q: Can the VCR indefinitely remain in the Record-Pause mode?

A: *No. The VCR shuts off automatically after 5 minutes to protect the heads.*

Q: What happens if the tape runs out during recording?

A: *The VCR automatically rewinds it to the beginning or, if Timer Recording, the cassette is ejected.*

TIMER RECORDING

Q: ○ and ⊖ remain lit on the display panel. Is there a problem?











A: *No. This is a normal condition for a timer recording in progress.*

Q: Can I programme the timer while I'm watching a tape or a TV broadcast?

A: *You won't see the picture as it is replaced by the on-screen menu, but the audio from the program or tape you're viewing can be heard.*

Troubleshooting

SYMPTOM	POSSIBLE CAUSE	CORRECTIVE ACTION
POWER		
1. No power is applied to the VCR.	<ul style="list-style-type: none"> The mains power cord is disconnected. 	Connect the mains power cord.
2. The clock is functioning properly, but the VCR cannot be powered.	<ul style="list-style-type: none"> ⊖ is displayed on the display panel with AUTO TIMER set to OFF. 	Press the ⊖ button to turn the ⊖ indicator off.
3. The Remote Control won't function.	<ul style="list-style-type: none"> The batteries are discharged. 	Replace the dead batteries with new ones.
TAPE TRANSPORT		
1. The tape does not run during recording. ○ lights up and preset position blinks on the display panel.	<ul style="list-style-type: none"> The VCR is in the RECORD PAUSE MODE. 	Press ► to resume recording.
2. The tape will not rewind or fast-forward.	<ul style="list-style-type: none"> The tape is already fully rewound or fast-forwarded. 	Check the cassette.
PLAYBACK		
1. The playback picture does not appear while the tape is running.	<ul style="list-style-type: none"> If you're using only the RF cable for connection... ...the TV's channel selector is not set to the Video Channel. ...the VCR's Video Channel has not been correctly set. If you're using both the RF cable and 21-pin SCART cable for connection, the TV is not set to the AV mode. 	<p>If you are using only the RF cable for connection... ...set the TV to the Video Channel. ...Perform Video Channel Set. (📖 pg. 48)</p> <p>If you are using both the RF cable and 21-pin SCART cable for connection, set the TV to its AV mode.</p>
2. Noise appears during visual search.	<ul style="list-style-type: none"> This is normal. 	
3. Noise appears during normal playback.	<ul style="list-style-type: none"> The automatic tracking mode is engaged. 	Try manual tracking. (📖 pg. 30)
4. The playback picture is blurred or interrupted while TV broadcasts are clear or USE CLEANING CASSETTE message appears on the screen.	<ul style="list-style-type: none"> The video heads may be dirty. 	Use a dry cleaning cassette JVC TCL-2U or consult your JVC dealer.
5. Breaks are noticeable in Hi-Fi soundtrack.	<ul style="list-style-type: none"> Automatic tracking is engaged. 	Try manual tracking (📖 pg. 30) or press AUDIO to change the soundtrack to NORM (📖 pg. 32).

SYMPTOM	POSSIBLE CAUSE	CORRECTIVE ACTION
RECORDING		
1. Recording cannot be started.	<ul style="list-style-type: none"> There is no cassette loaded, or the cassette loaded has had its record safety tab removed. 	Insert a cassette, or using adhesive tape, cover the hole where the tab was removed.
2. TV broadcasts cannot be recorded.	<ul style="list-style-type: none"> L-1, L-2 or SAT has been selected as the input mode. 	Set to the desired preset.
3. Tape-to-tape editing is not possible.	<ul style="list-style-type: none"> The source (another VCR, camcorder) has not been properly connected. All necessary power switches have not been turned on. The input mode is not correct. 	<p>Confirm that the source is properly connected.</p> <p>Confirm that all units' power switches are turned on.</p> <p>Set the input mode to L-1 or L-2.</p>
4. Camcorder recording is not possible.	<ul style="list-style-type: none"> The camcorder has not been properly connected. The input mode is not correct. 	<p>Confirm that the camcorder is properly connected.</p> <p>Set the input mode to L-1 or L-2.</p>
TIMER RECORDING		
1. Timer recording won't work.	<ul style="list-style-type: none"> The clock and/or the timer have been set incorrectly. The timer is not engaged. 	<p>Re-perform the clock and/or timer settings.</p> <p>Press  and confirm that  is displayed on the display panel.</p>
2. Timer programming is not possible.	<ul style="list-style-type: none"> Timer recording is in progress. 	Timer programming can't be performed while a timer recording is in progress. Wait until it finishes.
3.  on the display panel won't stop blinking.	<ul style="list-style-type: none"> The timer is engaged but there's no cassette loaded. 	Load a cassette with the record safety tab intact.
4.  ,  and  on the display panel won't stop blinking.	<ul style="list-style-type: none"> The loaded cassette has had its record safety tab removed. The end of the tape was reached during timer recording. 	<p>Remove the cassette and cover the hole with adhesive tape, or insert a cassette with the record safety tab intact.</p> <p>The programme may not have been recorded in its entirety. Next time make sure you have enough time on the tape to record the entire programme.</p>
5.  blinks for 10 seconds and the Timer mode is disengaged.	<ul style="list-style-type: none">  has been pressed when there are no programs in memory, or the timer record information has been programmed incorrectly. 	Check the programmed data and re-programme as necessary, then press  again.
6. The VIDEO Plus+ system does not timer record properly.	<ul style="list-style-type: none"> The VCR's preset positions have been set incorrectly. 	Refer to Guide Program Numbers ( pg. 56) and re-perform the procedure.

SYMPTOM	POSSIBLE CAUSE	CORRECTIVE ACTION
OTHER PROBLEMS		
1. Whistling or howling is heard from the TV during camcorder recording.	<ul style="list-style-type: none"> • The camcorder's microphone is too close to the TV. • The TV's volume is too high. 	Position the camcorder so its microphone is away from the TV. Turn the TV's volume down.
2. When scanning channels, some of them are skipped over.	<ul style="list-style-type: none"> • Those channels have been designated to be skipped. 	If you need the skipped channels, restore them.
3. The preset cannot be changed.	<ul style="list-style-type: none"> • Recording is in progress. 	Press to pause the recording, change presets, then press ▶ to resume recording.
4. Channel settings that were made manually seem to have changed or disappeared.	<ul style="list-style-type: none"> • After the manual settings were made, Auto Channel Set was performed. 	Perform manual setting again.
5. No channels are stored in the VCR's memory.	<ul style="list-style-type: none"> • The TV aerial cable was not connected to the VCR when Auto Set Up was performed. • The fully-wired 21-pin SCART cable was not connected between TV and the VCR when Preset Download was performed. 	Turn off the VCR once and connect the TV aerial cable to the VCR properly, then turn on the VCR again. Then perform Auto Setup again (🔧 pg. 10). Turn off the VCR once and connect the fully-wired 21-pin SCART cable to the VCR properly, then turn on the VCR again. Then perform Preset Download again (🔧 pg. 11).

List of Terms

A		N	
Auto Channel Setup	49	Next Function Memory	46
Auto Satellite Programme Recording	39	NICAM Stereo and Bilingual Broadcasts	32
Auto Setup	10	NTSC Tapes	14
Auto SP → LP Timer	45	O	
Auto Timer	45	On-Screen Display (O.S.D.)	44
B		P	
B.E.S.T.	31	Pause During Playback	16
C		Picture Control	30
Change Station Name	51	Playback	14
Change Station Preset Position	52	PlusCode Number	21
Clock Set	55	Power Save Mode	45
Connection to a Stereo System	47	Preset Download	11
Counter Display	19, 44	R	
D		Record a Programme While Watching Another	19
Delete a Channel	51	Recording	18
Direct Rec	35	Recording Resume Function	20
E		Repeat Playback	46
Editing	41	S	
Editing from a Camcorder	43	Satellite Controller	36
Editing Using Another VCR	42	Satellite Receiver Control Settings	36
Express Timer Programming	24	Single Frame Movement	16
F		Skip Search	33
Fine-Tuning Stored Channels	53	Slow Motion	17
G		Soundtrack Selection	32
Guide Program Numbers	56	SQPB	15
H		T	
High Speed Search	17	Tape Remaining Time	19, 44
I		Timer Warning Display	23, 25, 44
Index Search	33	Tuner Set	49
Instant ReView	33	TV Station Channel Number Guide	54
Instant Timer Recording	20	TV Station ID Guide	53
J		V	
Just Clock	55	Variable Speed Search	17
L		Video Channel Set	48
L-2 SELECT	41	Video Heads Cleaning	15
M		VIDEO Plus+® Timer Programming	21
Manual Channel Setup	50	W	
Manual Tracking	30	When Programmes Overlap Each Other	28
		24H Express Timer Programming	26

SPECIFICATIONS

GENERAL

Power requirement : AC 220 V – 240 V \sim , 50 Hz/60 Hz
Power consumption : on : 16 W, off : 4.0 W
Operating Temperature : 5°C to 40°C
Storage Temperature : –20°C to 60°C
Operating position : Horizontal only
Dimensions (WxHxD) : 400 mm x 94 mm x 278 mm
Weight : 3.4 kg
Format : VHS PAL standard
Maximum recording time :
(SP) : 240 min. with E-240 video cassette
(LP) : 480 min. with E-240 video cassette

VIDEO / AUDIO

Signal system : PAL-type colour signal and CCIR monochrome signal, 625 lines/50 fields
Recording system : DA4 (Double Azimuth) helical scan system
Signal-to-noise ratio : 45 dB
Horizontal resolution : 250 lines
Frequency range : 70 Hz to 10,000 Hz (Normal audio)
20 Hz to 20,000 Hz (Hi-Fi audio)
Input/Output : 21-pin SCART connectors
(IN/OUT x 1, IN/DECODER x 1)
RCA connectors
(AUDIO OUT x 1)

TUNER / TIMER

TV channel storage capacity : 99 positions (+AUX position)
Tuning system : Frequency synthesized tuner
Channel coverage : VHF 44.5 MHz – 143 MHz/
143 MHz – 470 MHz/
UHF 470 MHz – 862 MHz
Aerial output : UHF channels 22 – 69 (Adjustable)
Memory backup time : Approx. 10 min.

ACCESSORIES

Provided accessories : RF cable, Satellite Controller, Infrared remote control unit, 'AA' battery x 2

Specifications shown are for SP mode unless otherwise specified.
E.& O.E. Design and specifications subject to change without notice.

JVC
VICTOR COMPANY OF JAPAN, LIMITED